

GEVELS - VERTICALE MONTAGE
BUSINESS LINE ALPHA

G.CP.BL-V.01a
ONDERDETAIL - VARIANT 1
Verticale doorsnede

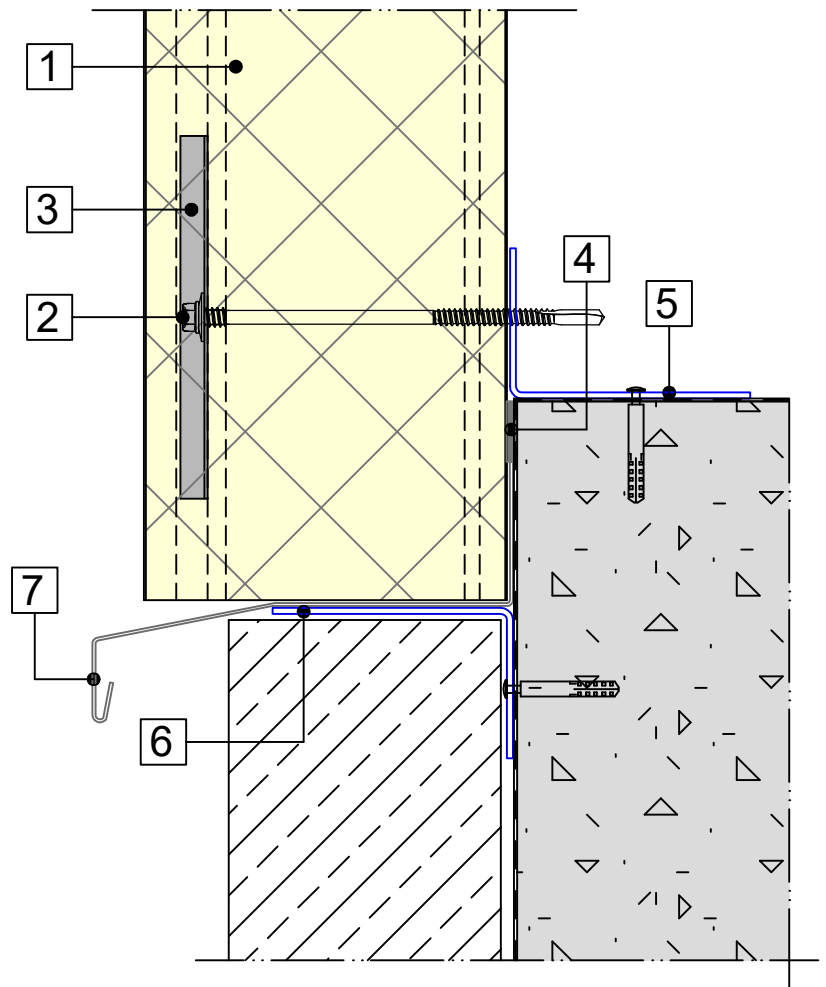

LEKDORPEL

$d \geq 0.60 \text{ mm}$



DRUKVERDEELPLAAT

afm. 120*31*9*1.5 mm



Nr.	Omschrijving	Schaal: 1:2.5
1	Sandwichpaneel	
2	Bevestigingsmiddel	
3	Drukverdeelplaat	
4	Zelfklevende afdichtingsband PE	
5	Stalen binnenhoek	
6	Paneeldrager	
7	Lekdorpel	

GEVELS - VERTICALE MONTAGE
BUSINESS LINE ALPHA

G.CP.BL-V.01b
ONDERDETAIL - VARIANT 2
Verticale doorsnede

STOOTPROFIEL*

$d \geq 0.60 \text{ mm}$



LEKDORPEL

$d \geq 0.60 \text{ mm}$



DRUKVERDEELPLAAT

afm. 120*31*9*1.5 mm

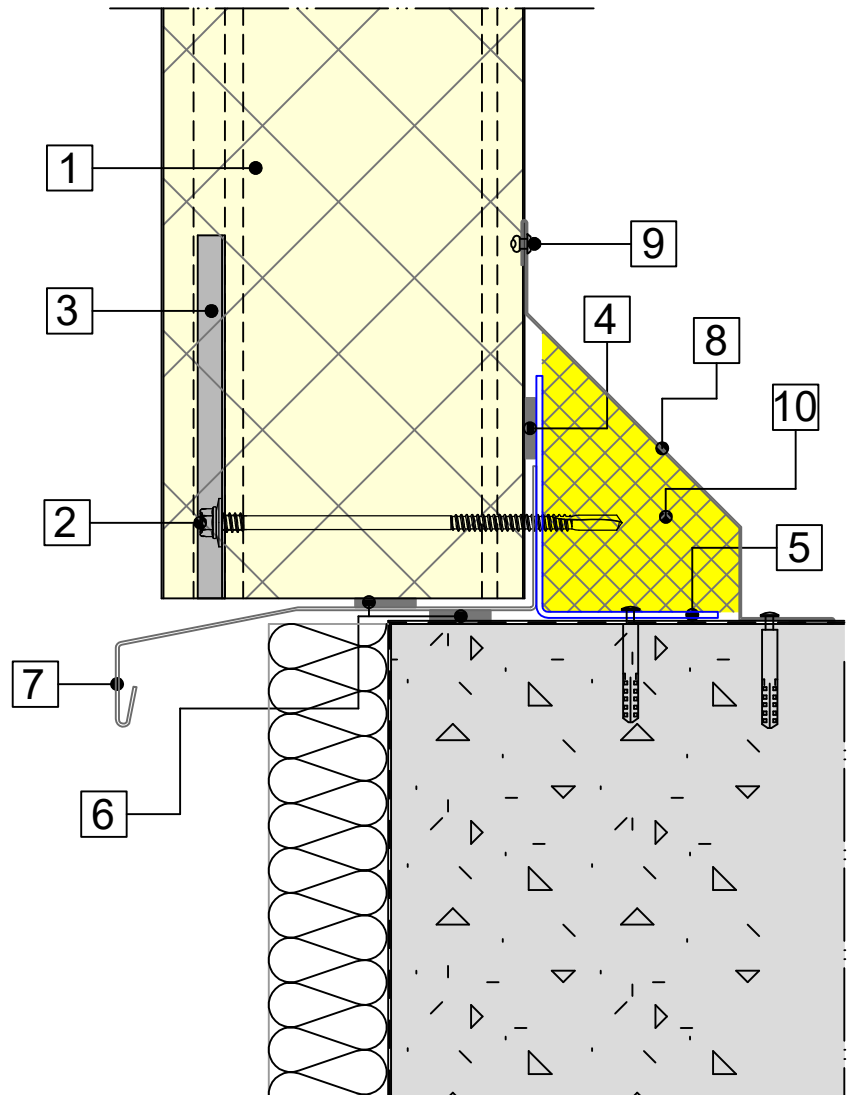

Nr.	Omschrijving
1	Sandwichpaneel
2	Bevestigingsmiddel
3	Drukverdeelplaat
4	Zelfklevende afdichtingsband PE
5	Stalen binnenhoek
6	PU afdichtingsband
7	Lekdorpel
8	Stootprofiel*
9	Popnagel*
10	Thermische isolatie*

Schaal: 1:2.5

* Optioneel

GEVELS - VERTICALE MONTAGE
BUSINESS LINE ALPHA

G.CP.BL-V.02a
VERDEKTE BEVESTIGING

Horizontale doorsnede

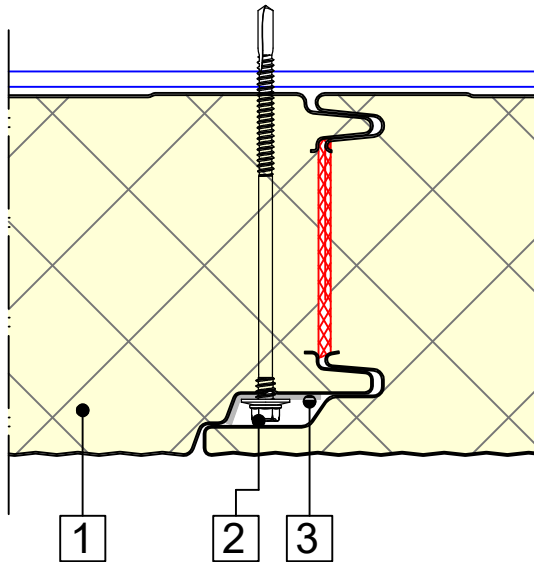

Verticale doorsnede

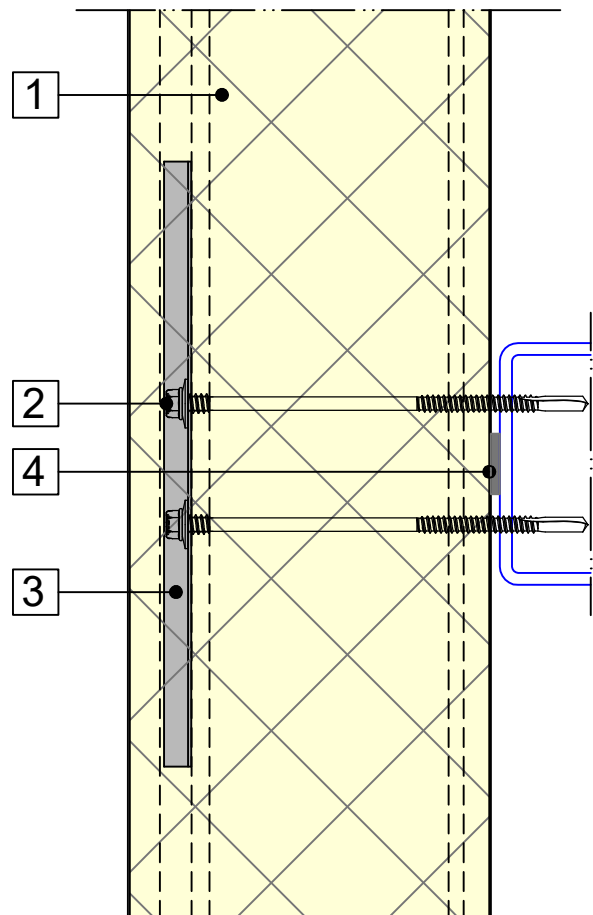

DRUKVERDEELPLAAT

*afm. 200*31*9*1.5 mm*



Nr.	Omschrijving	Schaal: 1:2.5
1	Sandwichpaneel	
2	Bevestigingsmiddel	
3	Drukverdeelplaat	
4	Zelfklevende afdichtingsband PE	

GEVELS - VERTICALE MONTAGE
BUSINESS LINE ALPHA

G.CP.BL-V-02b
HORIZONTALE STUIKNAAD
Verticale doorsnede

LEKDORPEL

$d \geq 0.60 \text{ mm}$



DRUKVERDEELPLAAT

afm. 120*31*9*1.5 mm

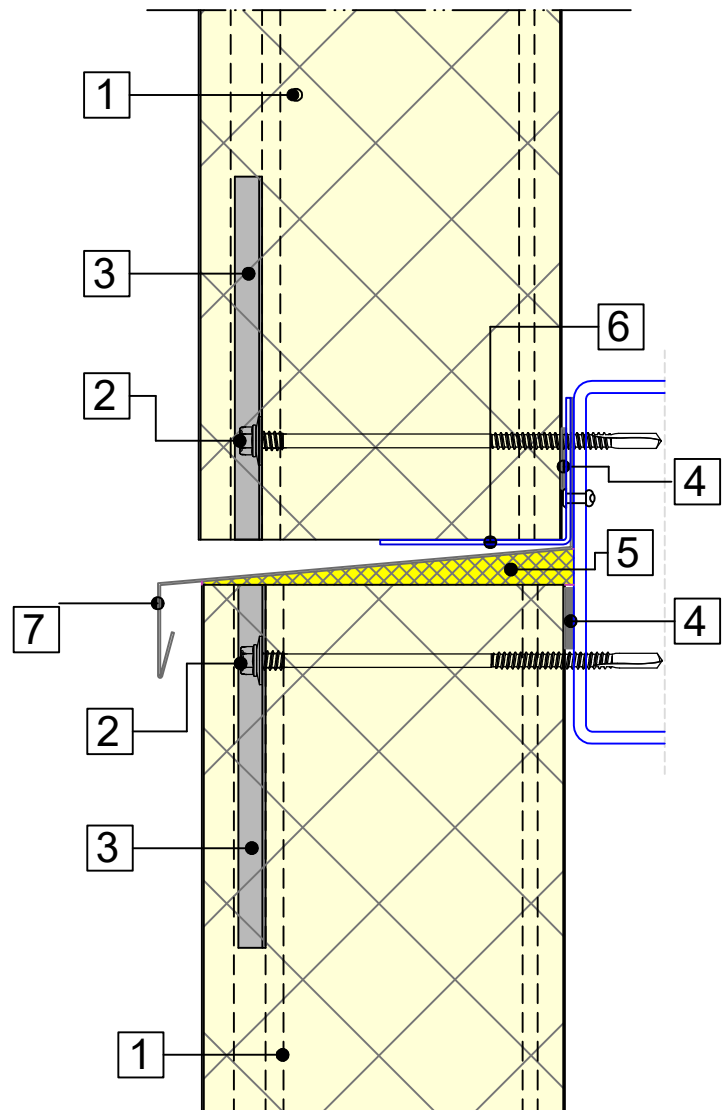

Nr.	Omschrijving	Schaal: 1:2.5
1	Sandwichpaneel	
2	Bevestigingsmiddel	
3	Drukverdeelplaat	
4	Zelfklevende afdichtingsband PE	
5	Thermische isolatie	
6	Paneeldrager	
7	Lekdorpel	

GEVELS - VERTICALE MONTAGE
BUSINESS LINE ALPHA

G.CP.BL-V.03a
DAKRAND DETAIL - VARIANT 1
Verticale doorsnede

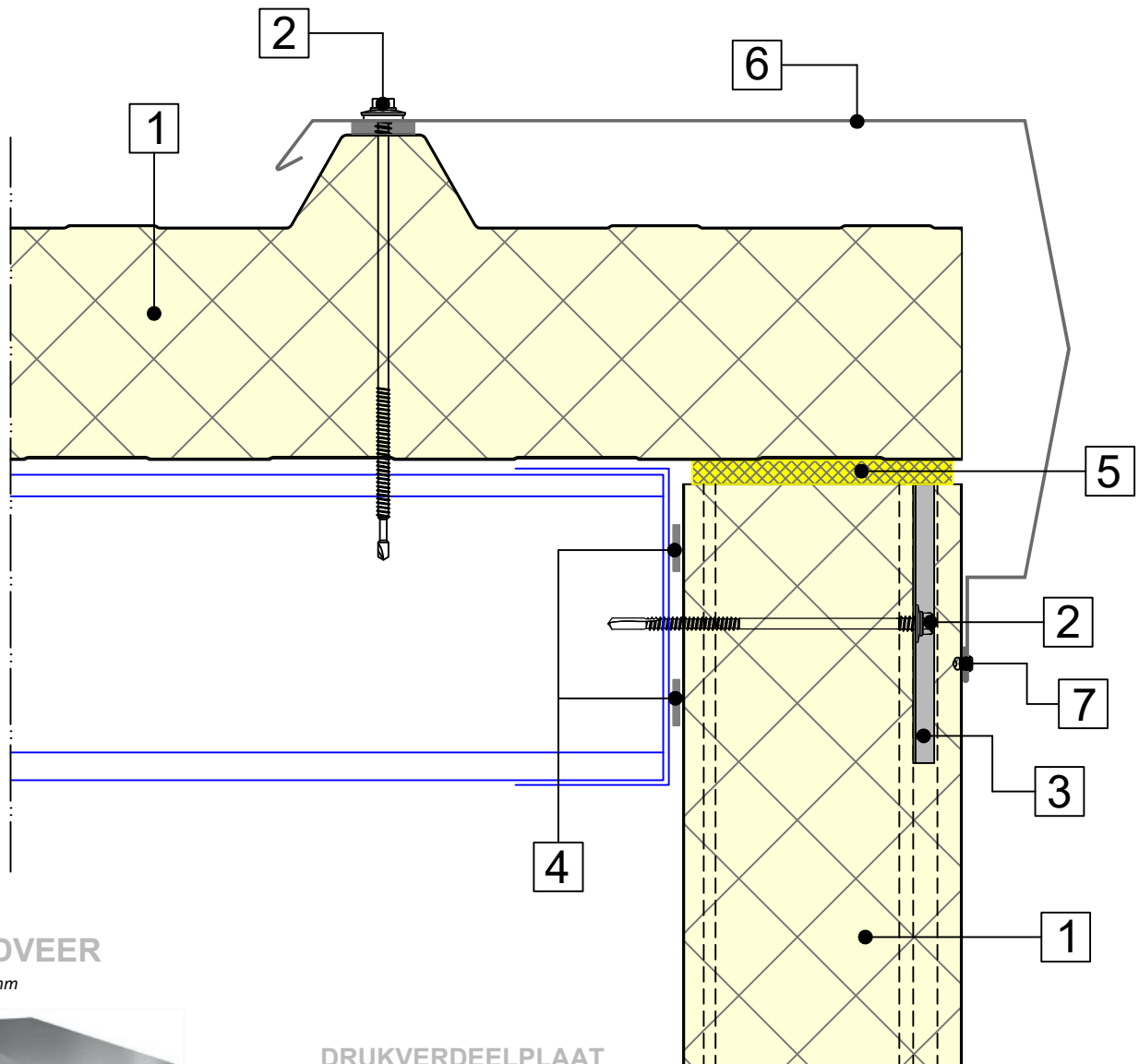

WINDVEER
 $d \geq 0.60 \text{ mm}$



DRUKVERDEELPLAAT
afm. 120*31*9*1.5 mm



Nr.	Omschrijving	Schaal: 1:3
1	Sandwichpaneel	
2	Bevestigingsmiddel	
3	Drukverdeelplaat	
4	Zelfklevende afdichtingsband PE	
5	Thermische isolatie	
6	Zetwerk	
7	Popnagel	

GEVELS - VERTICALE MONTAGE
BUSINESS LINE ALPHA

G.CP.BL-V.03b
DAKRAND DETAIL - VARIANT 2
Verticale doorsnede

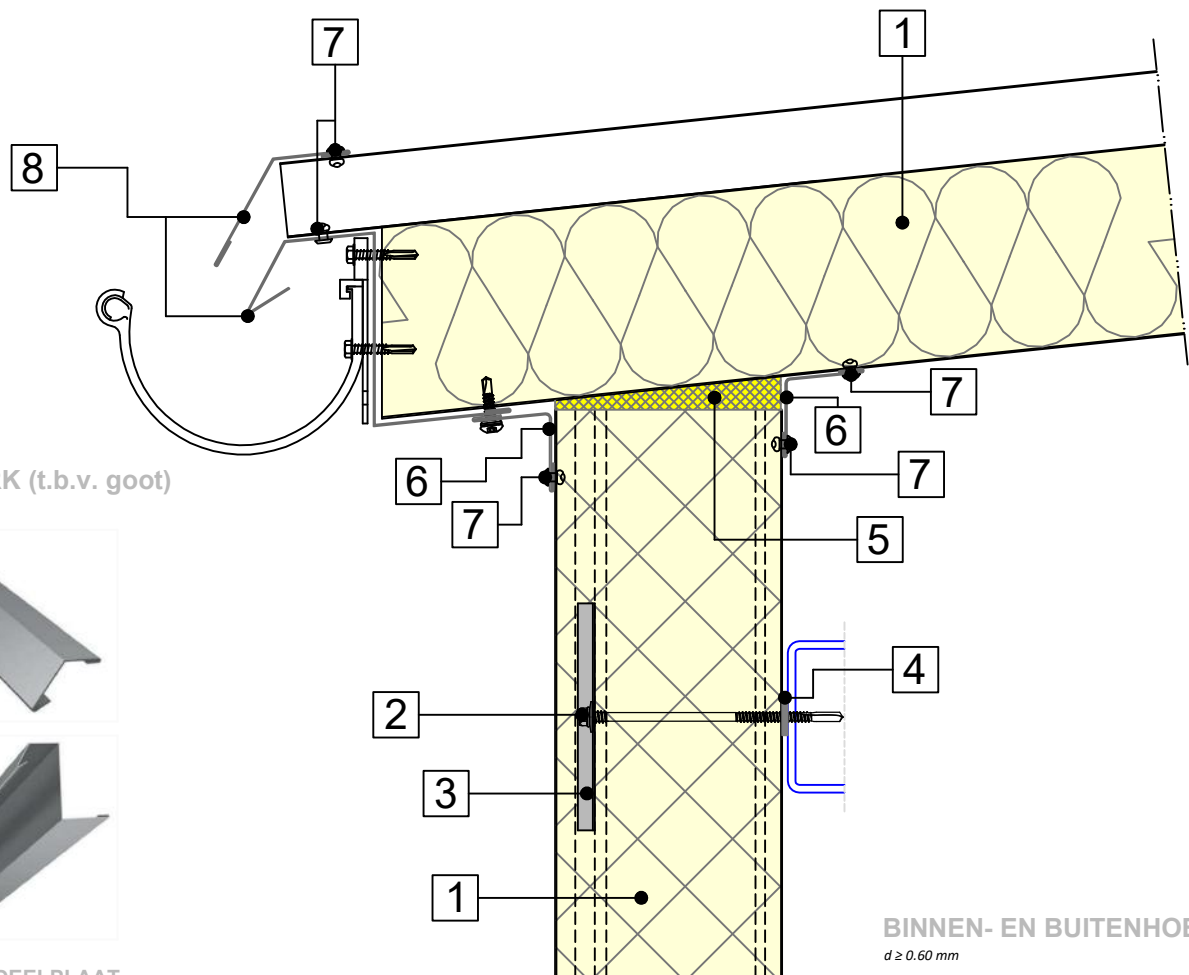

ZETWERK (t.b.v. goot)
 $d \geq 0.60 \text{ mm}$



DRUKVERDEELPLAAT
 $\text{afm. } 120 \times 31 \times 9 \times 1.5 \text{ mm}$



BINNEN- EN BUITENHOEKJE
 $d \geq 0.60 \text{ mm}$



Nr.	Omschrijving	Schaal: 1:4
1	Sandwichpaneel	
2	Bevestigingsmiddel	
3	Drukverdeelplaat	
4	Zelfklevende afdichtingsband PE	
5	Thermische isolatie	
6	Stalen buiten/binnenhoekje	
7	Popnagel	
8	Stalen zetwerk t.b.v. waterinloop goot	

GEVELS - VERTICALE MONTAGE
BUSINESS LINE ALPHA

G.CP.BL-V.03c
DAKRAND DETAIL - VARIANT 3
Verticale doorsnede

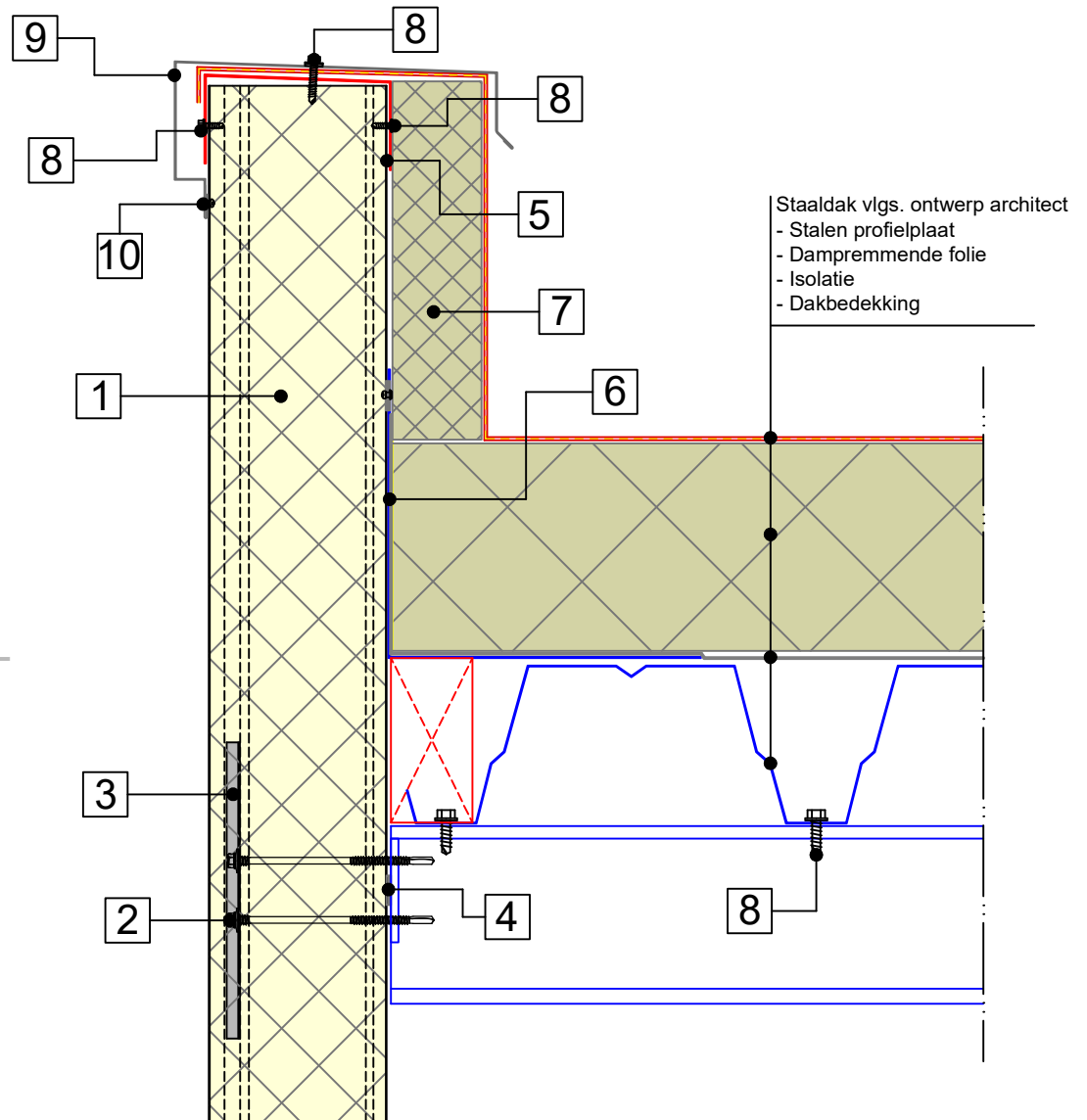

DAKRAND PROFIEL

$d \geq 0.60 \text{ mm}$



DRUKVERDEELPLAAT

ofm. 200*31*9*1.5 mm



Nr.	Omschrijving	Schaal: 1:5
1	Sandwichpaneel	
2	Bevestigingsmiddel	
3	Drukverdeelplaat	
4	Zelfklevende afdichtingsband PE	
5	U-profiel	
6	Haakse hoek	
7	Isolatie	
8	Bevestigingsmiddel	
9	Dakrand profiel	
10	Popnagel	

GEVELS - VERTICALE MONTAGE
BUSINESS LINE ALPHA

G.CP.BL-V.04a
UITWENDIGE HOEK - VARIANT 1
Horizontale doorsnede

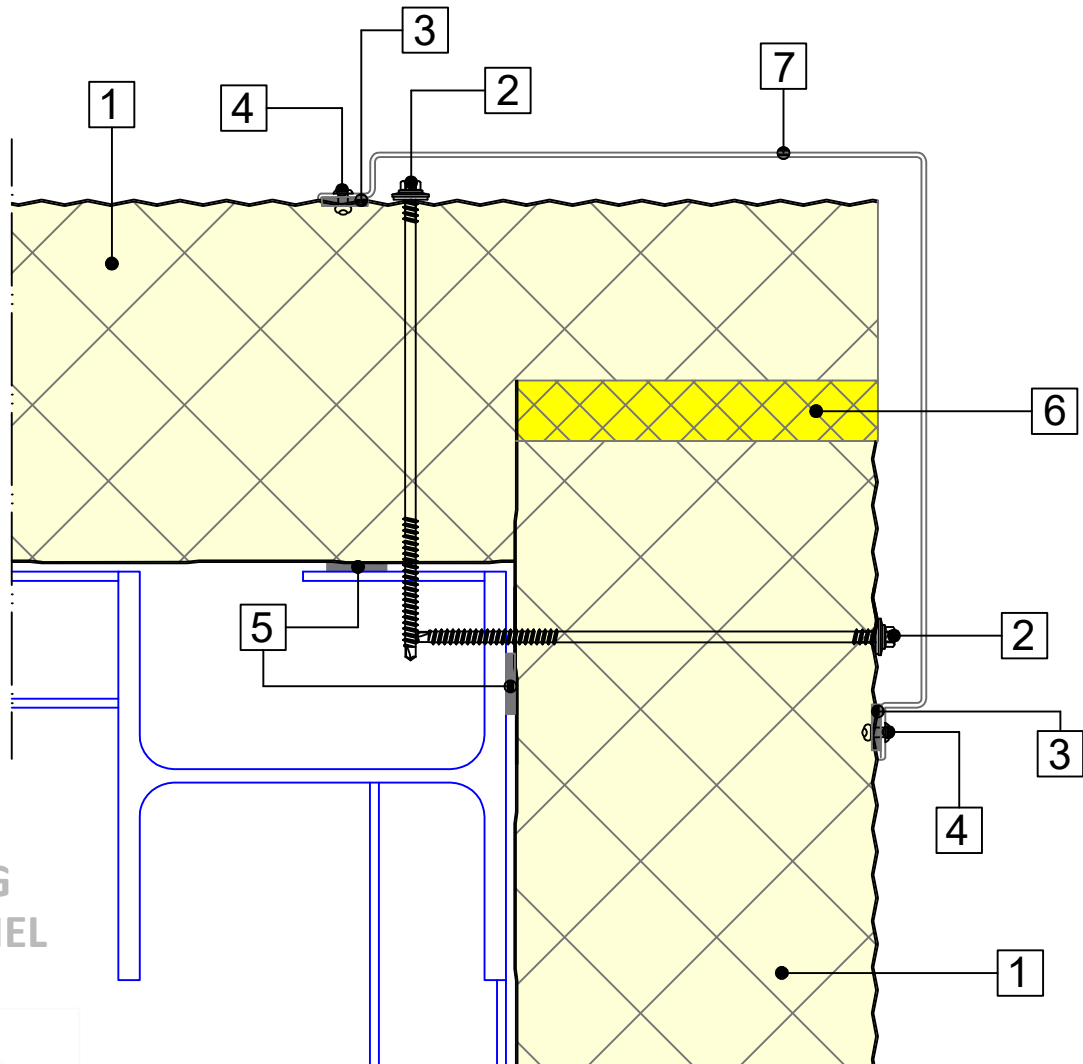

**UITWENDIG
HOEKPROFIEL**

$d \geq 0.60 \text{ mm}$



Nr.	Omschrijving	Schaal: 1:2.5
1	Sandwichpaneel	
2	Bevestigingsmiddel	
3	Zelfklevende afdichtingsband EPDM	
4	Popnagel	
5	Zelfklevende afdichtingsband PE	
6	Thermische isolatie	
7	Uitwendig hoekprofiel	

GEVELS - VERTICALE MONTAGE
BUSINESS LINE ALPHA

G.CP.BL-V.04b
UITWENDIGE HOEK - VARIANT 2
Horizontale doorsnede

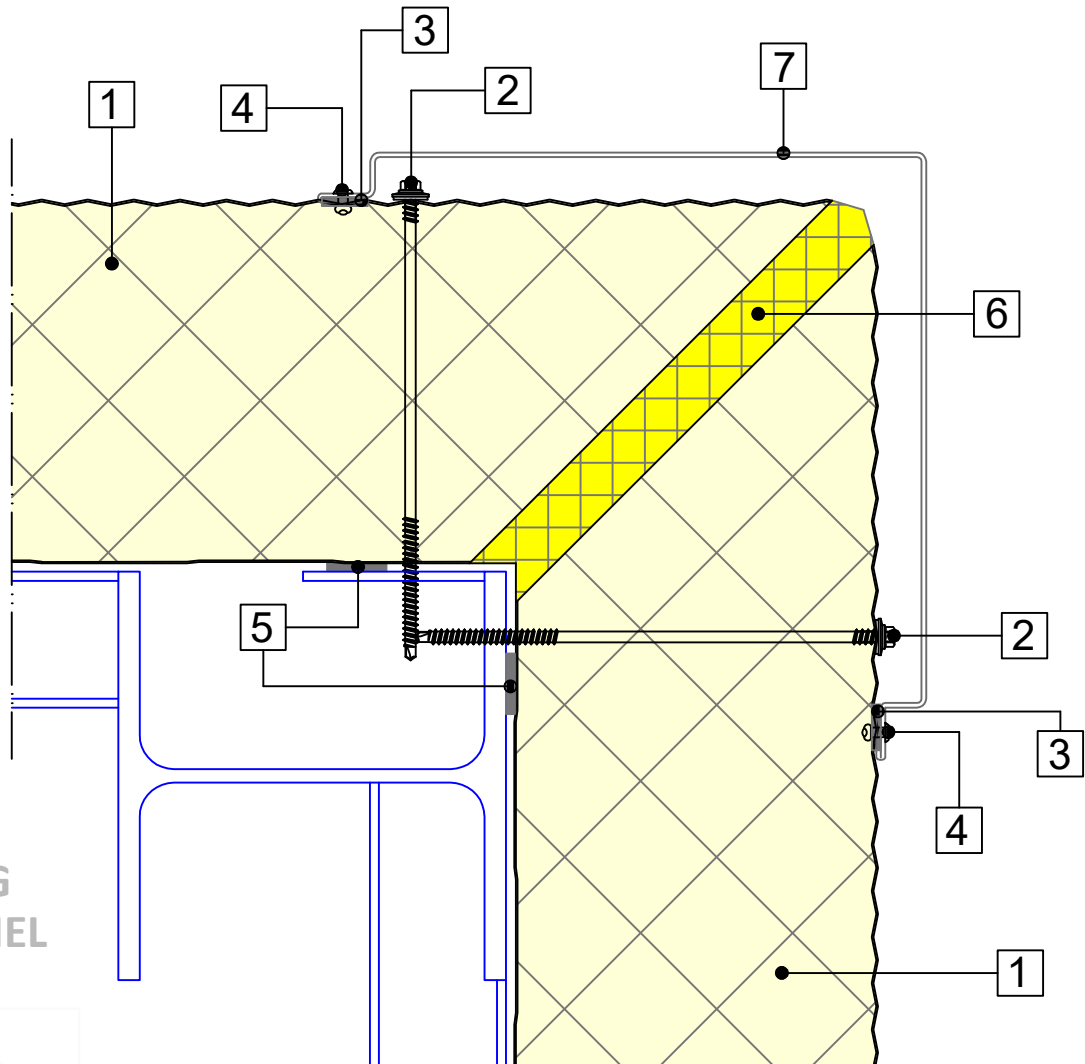

**UITWENDIG
HOEKPROFIEL**

$d \geq 0.60 \text{ mm}$



Nr.	Omschrijving	Schaal: 1:2.5
1	Sandwichpaneel	
2	Bevestigingsmiddel	
3	Zelfklevende afdichtingsband EPDM	
4	Popnagel	
5	Zelfklevende afdichtingsband PE	
6	Thermische isolatie	
7	Uitwendig hoekprofiel	

GEVELS - VERTICALE MONTAGE
BUSINESS LINE ALPHA

G.CP.BL-V.04c
PREFAB HOEK - VARIANT 1
Horizontale doorsnede

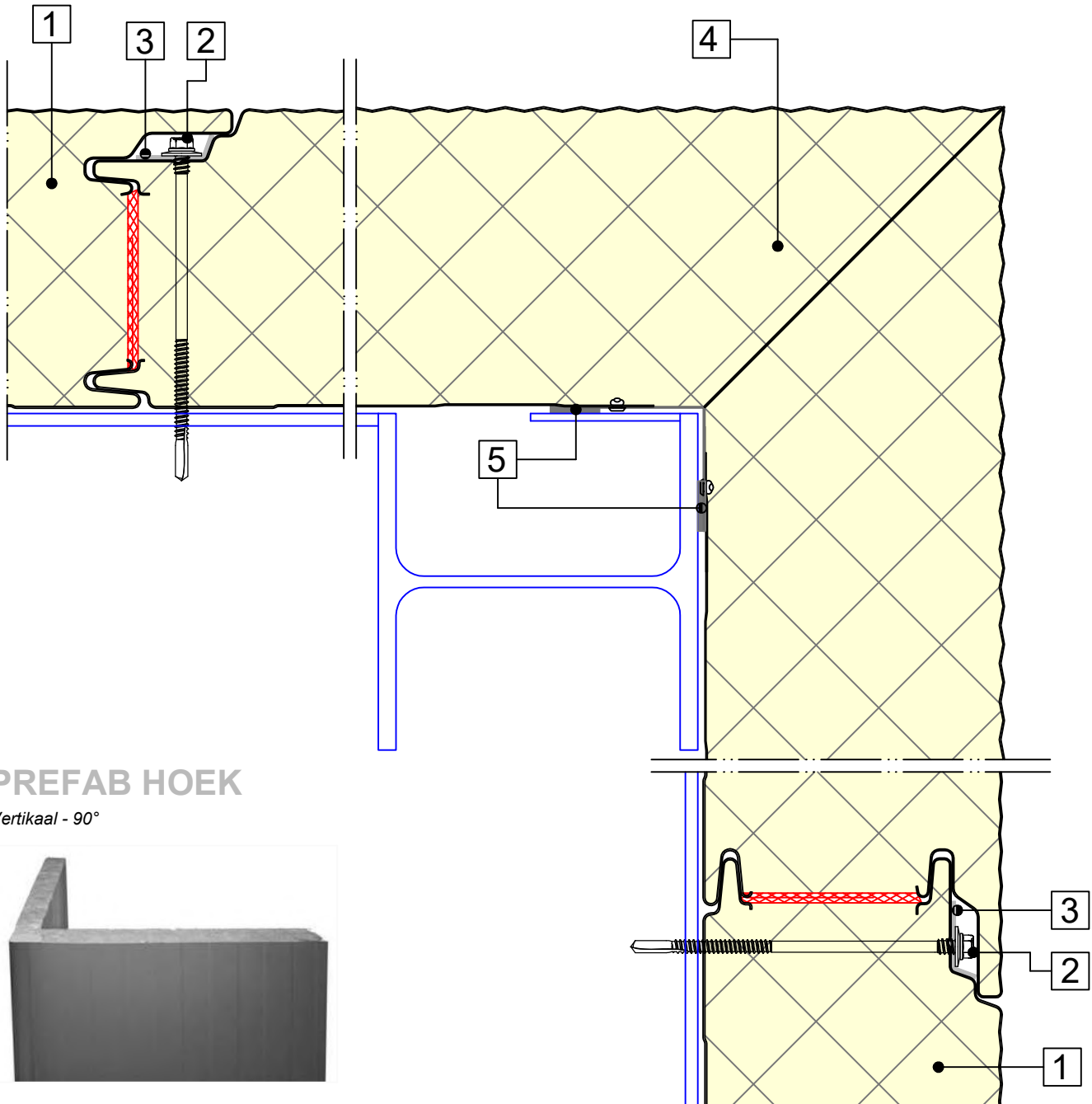

PREFAB HOEK

Vertikaal - 90°



Nr.	Omschrijving	Schaal: 1:2.5
1	Sandwichpaneel	
2	Bevestigingsmiddel	
3	Drukverdeelplaat	
4	Prefab verticaal hoekpaneel 90°	
5	Zelfklevende afdichtingsband PE	

GEVELS - VERTICALE MONTAGE
BUSINESS LINE ALPHA

G.CP.BL-V.04d
PREFAB HOEK - VARIANT 2
Horizontale doorsnede

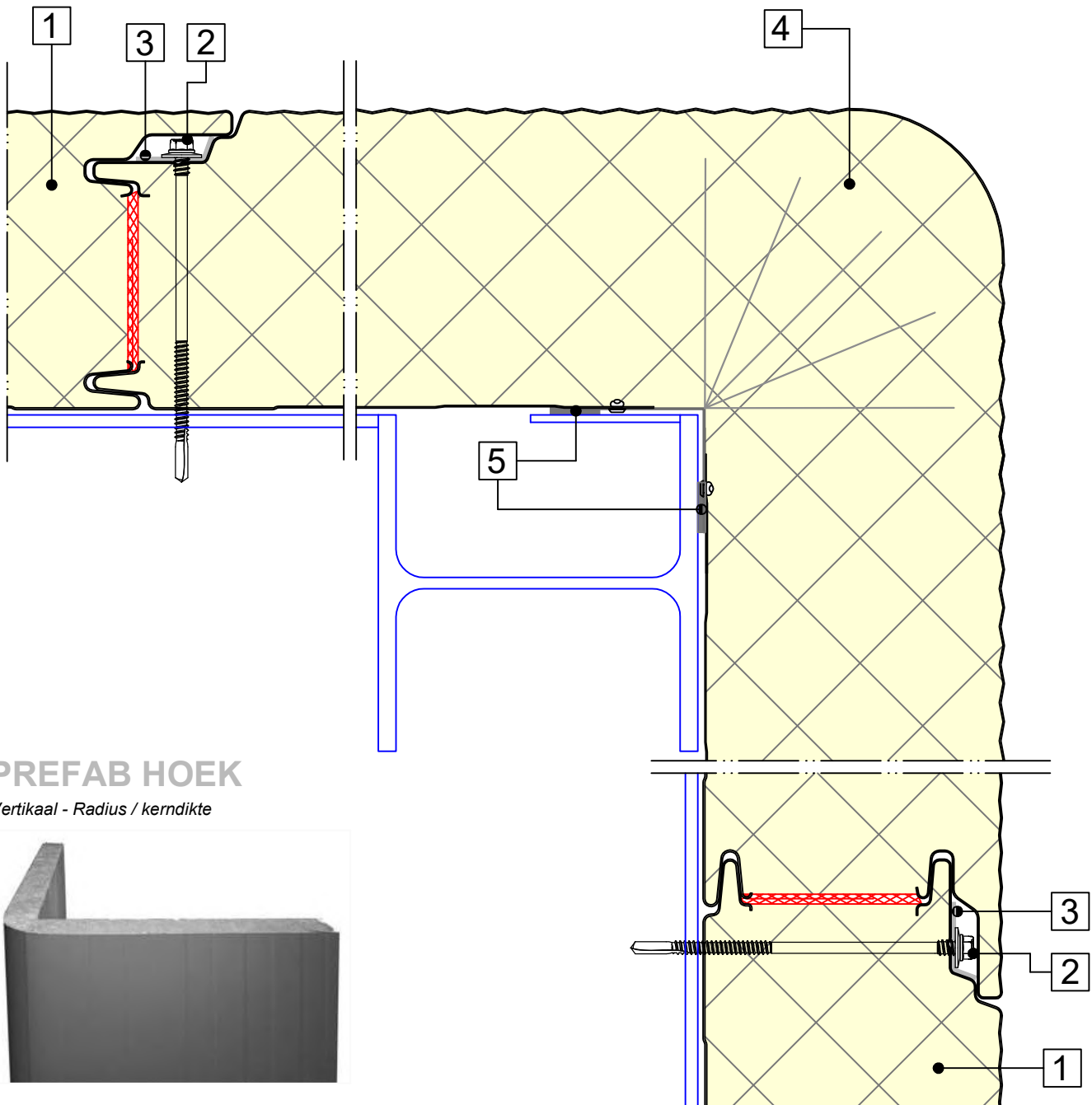

PREFAB HOEK

Vertikaal - Radius / kerndikte



Nr.	Omschrijving	Schaal: 1:2.5
1	Sandwichpaneel	
2	Befestigingsmiddel	
3	Drukverdeelplaat	
4	Prefab verticaal hoekpaneel 90°	
5	Zelfklevende afdichtingsband PE	

GEVELS - VERTICALE MONTAGE
BUSINESS LINE ALPHA

G.CP.BL-V.05a
INWENDIGE HOEK
Horizontale doorsnede

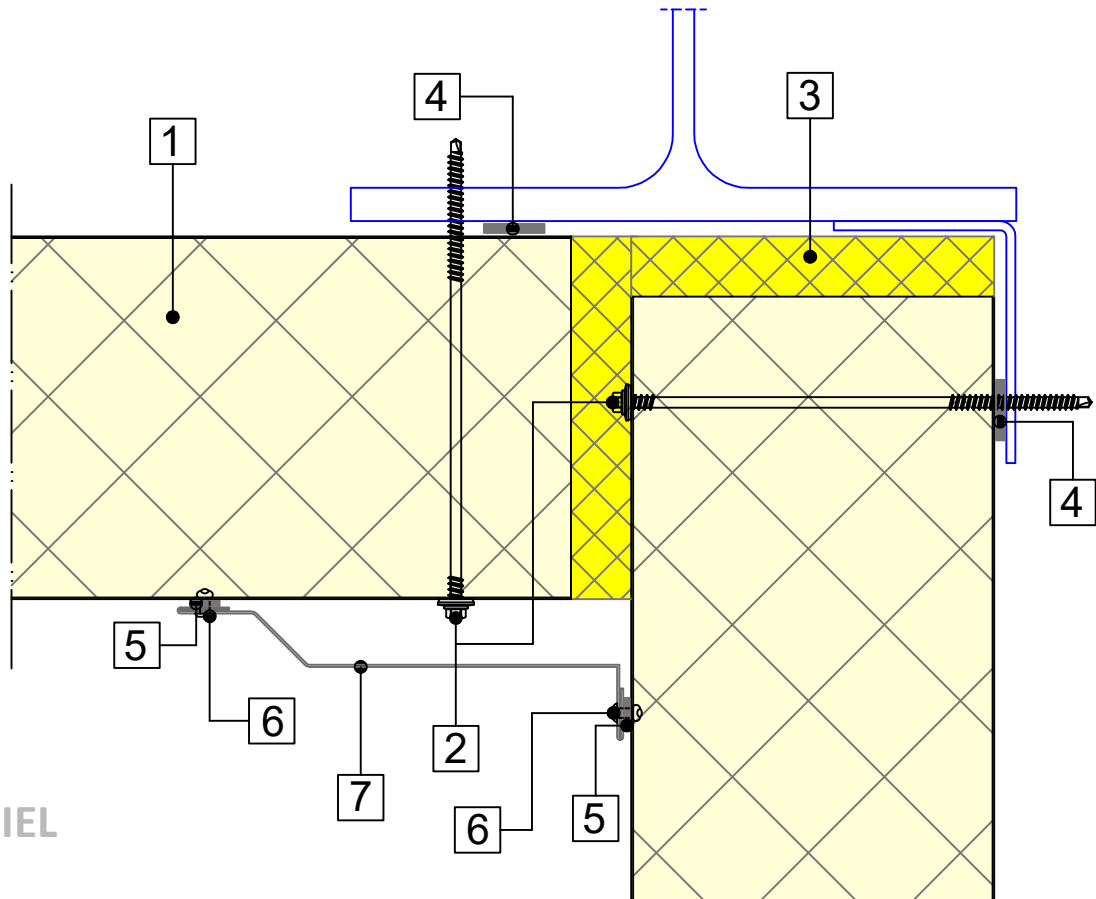

**INWENDIG
HOEKPROFIEL**

$d \geq 0.60 \text{ mm}$



Nr.	Omschrijving	Schaal: 1:2.5
1	Sandwichpaneel	
2	Bevestigingsmiddel	
3	Thermische isolatie	
4	Zelfklevende afdichtingsband PE	
5	Afdichtingsband	
6	Popnagel	
7	Inwendig hoekprofiel	

GEVELS - VERTICALE MONTAGE
BUSINESS LINE ALPHA

G.CP.BL-V.06a
BOVENDETAIL KOZIJN
Verticale doorsnede

ONDERPROFIEL LEKDORPEL

$d \geq 0.60 \text{ mm}$



LEKDORPEL

$d \geq 0.60 \text{ mm}$



DRUKVERDEELPLAAT

afm. 120*31*9*1.5 mm

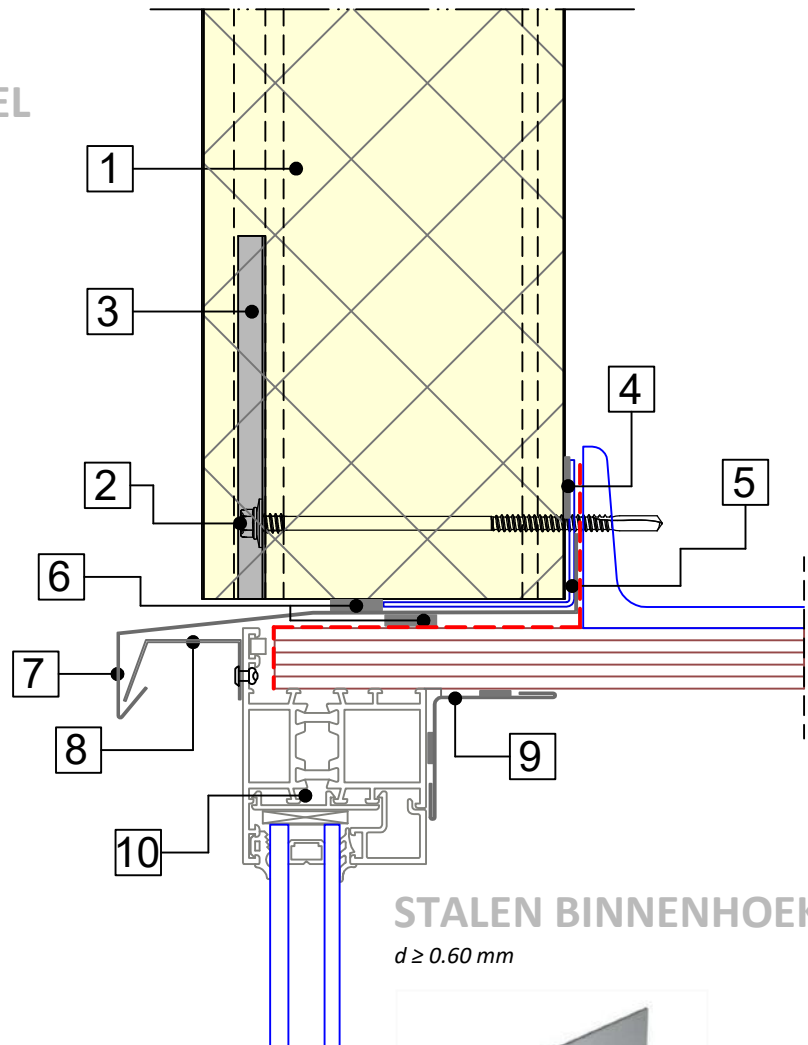

STALEN BINNENHOEK

$d \geq 0.60 \text{ mm}$



Nr.	Omschrijving
1	Sandwichpaneel
2	Bevestigingsmiddel
3	Drukverdeelplaat
4	Zelfklevende afdichtingsband PE
5	Paneeldrager
6	Afdichtingsband PU
7	Lekdorpel
8	Onderprofiel lekdorpel
9	Stalen binnenhoek
10	Kozijn; inbouw conform opgave leverancier

Schaal: 1:2.5

GEVELS - VERTICALE MONTAGE
BUSINESS LINE ALPHA

G.CP.BL-V.06b
ONDERDETAIL KOZIJN
Verticale doorsnede

STALEN BINNENHOEK

$d \geq 0.60 \text{ mm}$



RAAMDORPEL

$d \geq 0.60 \text{ mm}$



DRUKVERDEELPLAAT

afm. 120*31*9*1.5 mm

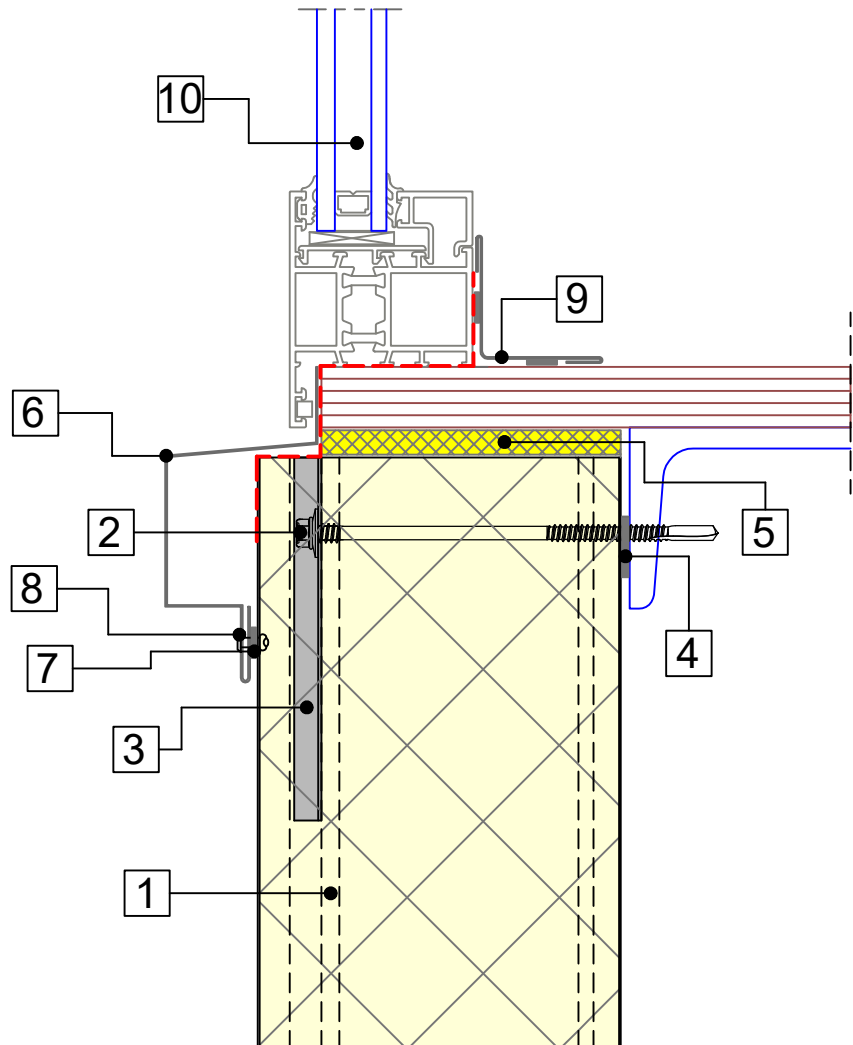

Nr.	Omschrijving	Schaal: 1:2.5
1	Sandwichpaneel	
2	Bevestigingsmiddel	
3	Drukverdeelplaat	
4	Zelfklevende afdichtingsband PE	
5	Thermische isolatie	
6	Raamdorpel	
7	Afdichtingsband PU	
8	Popnagel	
9	Stalen binnenhoek	
10	Kozijn; inbouw conform opgave leverancier	

GEVELS - VERTICALE MONTAGE
BUSINESS LINE ALPHA

G.CP.BL-V.06c
DAGKANT KOZIJN
Horizontale doorsnede

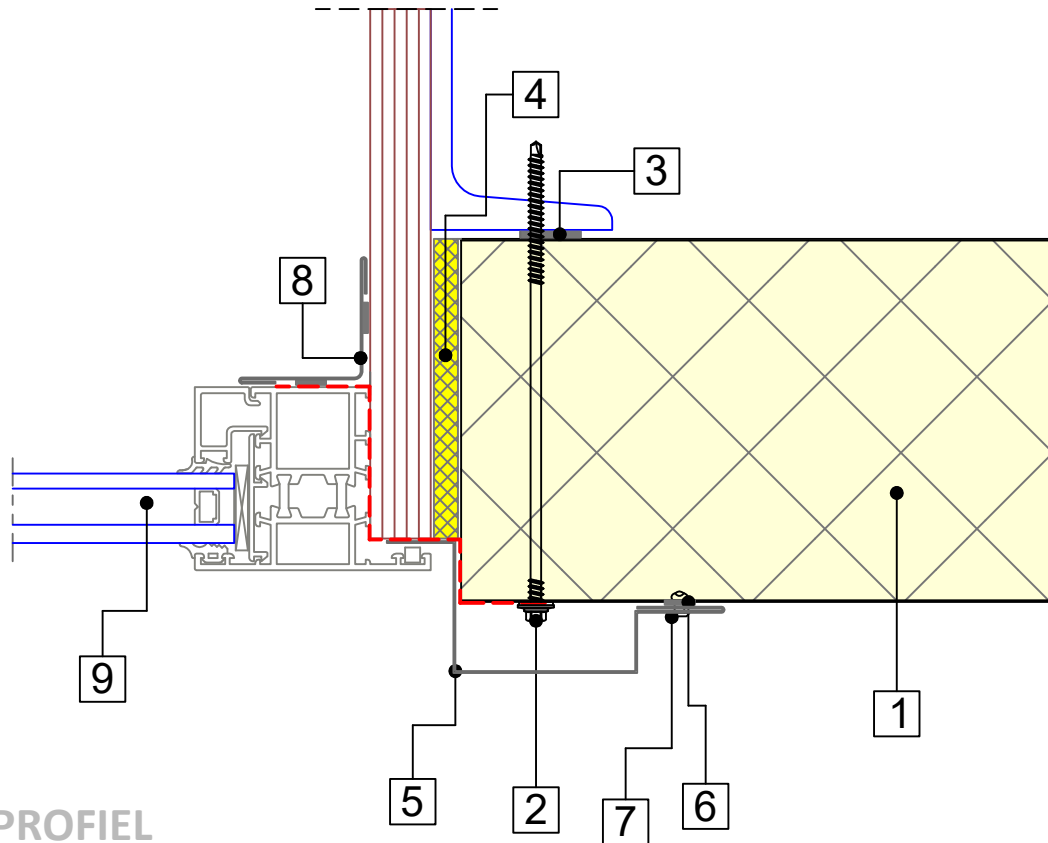

DAGKANT PROFIEL

$d \geq 0.60 \text{ mm}$



STALEN BINNENHOEK

$d \geq 0.60 \text{ mm}$



Nr.	Omschrijving	Schaal: 1:2.5
1	Sandwichpaneel	
2	Bevestigingsmiddel	
3	Zelfklevende afdichtingsband PE	
4	Thermische isolatie	
5	Dagkantprofiel	
6	Afdichtingsband PU	
7	Popnagel	
8	Stalen binnenhoek	
9	Kozijn; inbouw conform opgave leverancier	

GEVELS - VERTICALE MONTAGE
BUSINESS LINE ALPHA

G.CP.BL-V.06d
KLEMKOZIJN
Horizontale doorsnede

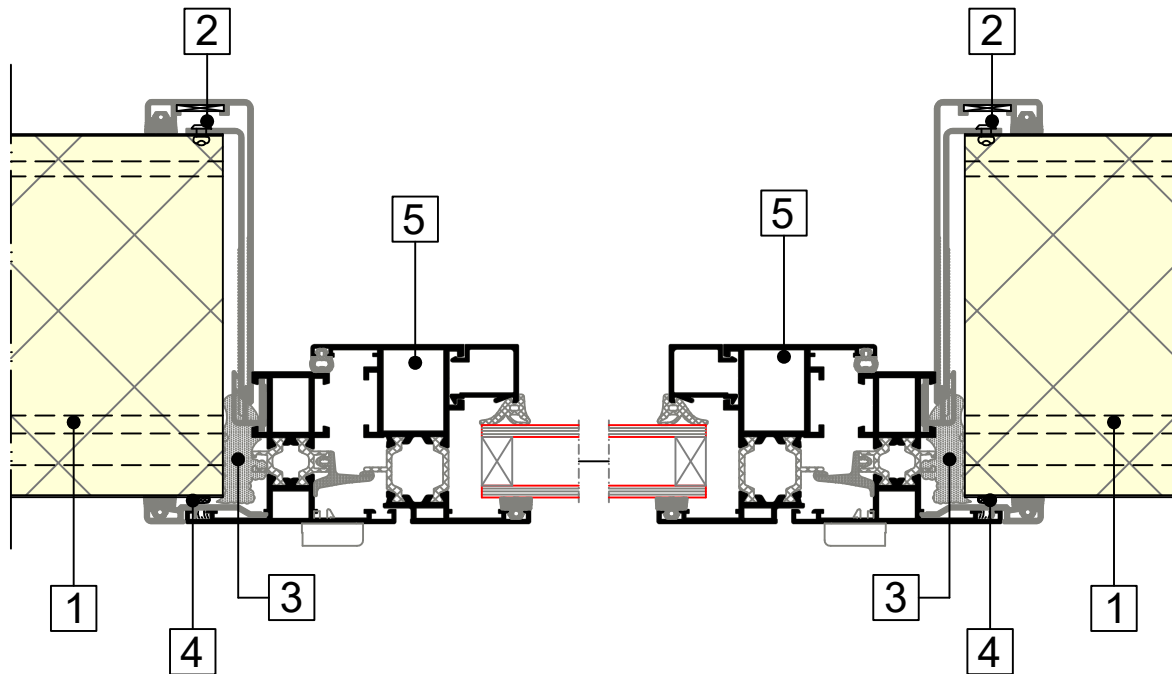

CASTELLUM KOZIJN

Inbouw conform opgave Primoclad Europe.
www.primoclad.nl



Nr.	Omschrijving	Schaal: 1:2.5
1	Sandwichpaneel	
2	Popnagel	
3	PUR-schuim	
4	Siliconen butyleen kit	
5	Raam Castellum [59S]; inbouw conform opgave leverancier	

GEVELS - VERTICALE MONTAGE
BUSINESS LINE ALPHA

G.CP.BL-V.06e
KLEMKOZIJN
Verticale doorsnede

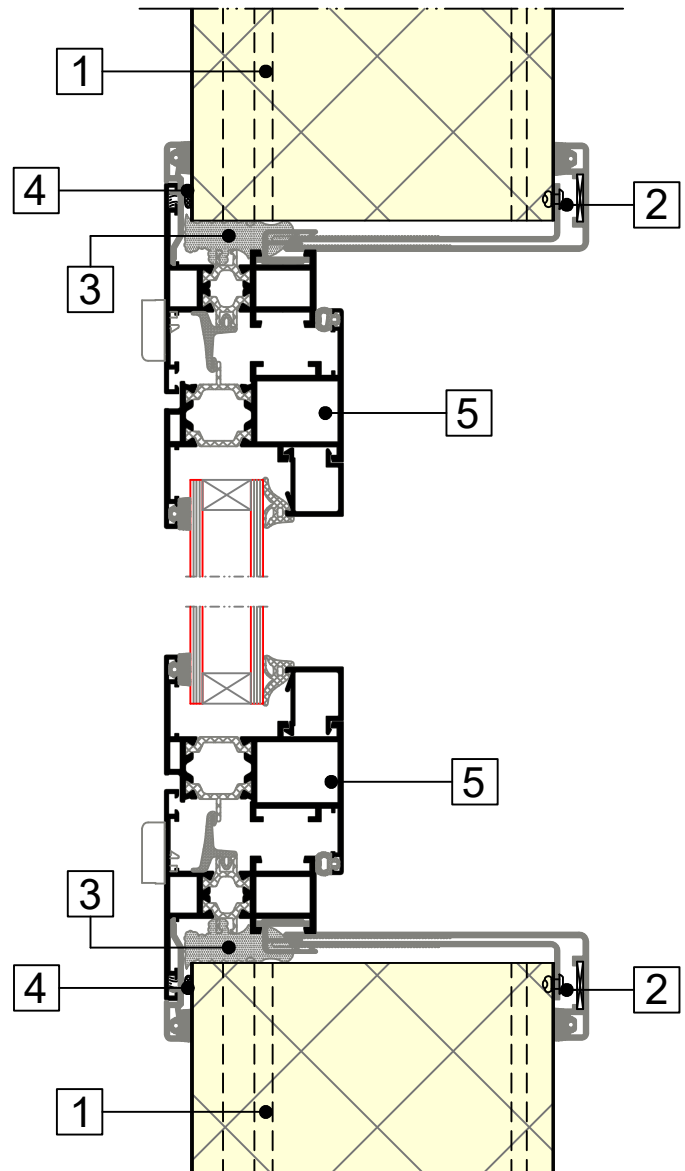

CASTELLUM KOZIJN

Inbouw conform opgave Primoclad Europe.
www.primoclad.nl



Nr.	Omschrijving	Schaal: 1:2.5
1	Sandwichpaneel	
2	Popnagel	
3	PUR-schuim	
4	Siliconen butyleen kit	
5	Raam Castellum [59S]; inbouw conform opgave leverancier	

GEVELS - VERTICALE MONTAGE
BUSINESS LINE ALPHA

G.CP.BL-V.06f
KLEMKOZIJN DEUR

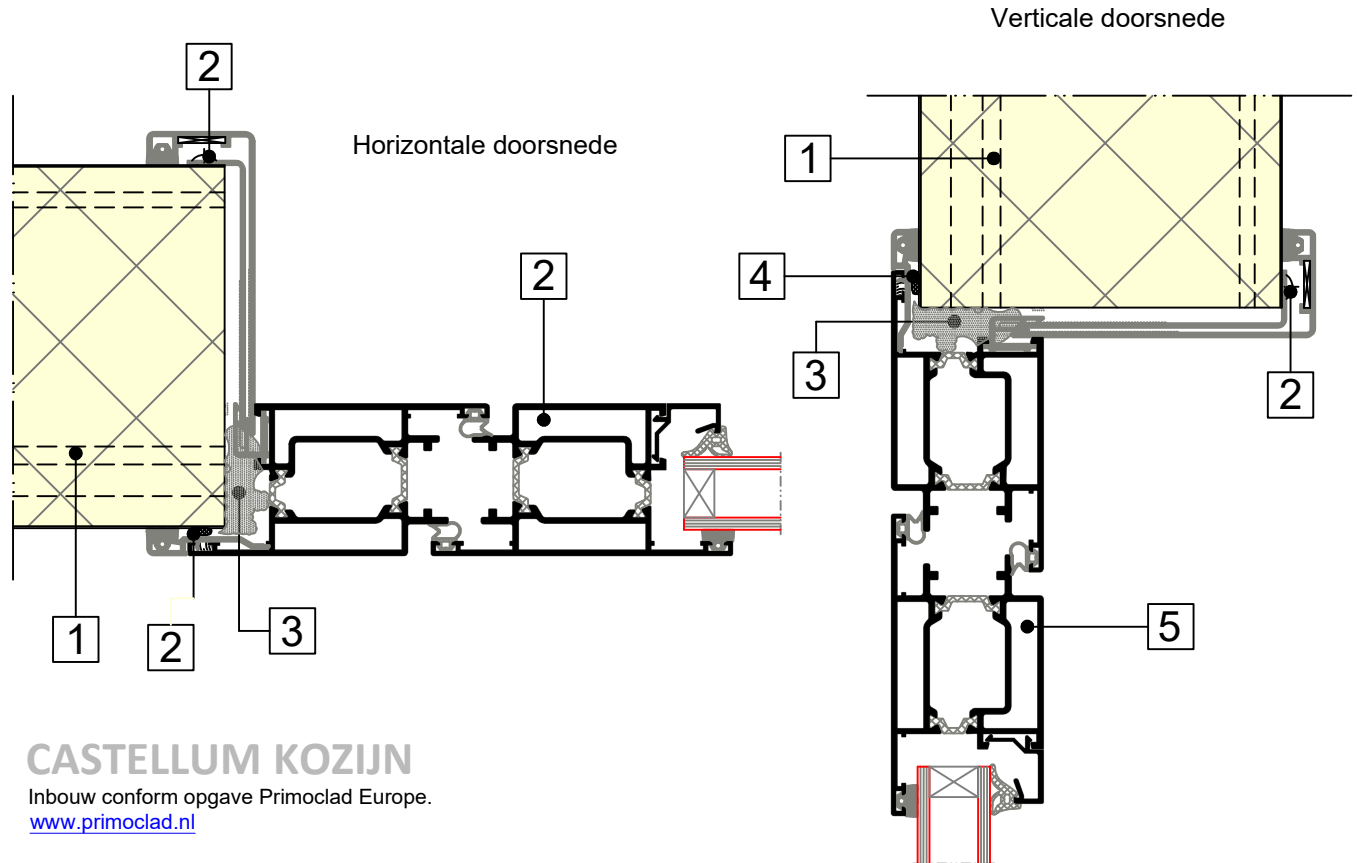

CASTELLUM KOZIJN

Inbouw conform opgave Primoclad Europe.
www.primoclad.nl



Nr.	Omschrijving	Schaal: 1:2.5
1	Sandwichpaneel	
2	Popnagel	
3	PUR-schuim	
4	Siliconen butyleen kit	
5	Deur Castellum [59S]; inbouw conform opgave leverancier	

GEVELS - VERTICALE MONTAGE
BUSINESS LINE ALPHA

G.CP.BL-V.07a
DAGKANT INDUSTRIEDEUR
Horizontale doorsnede

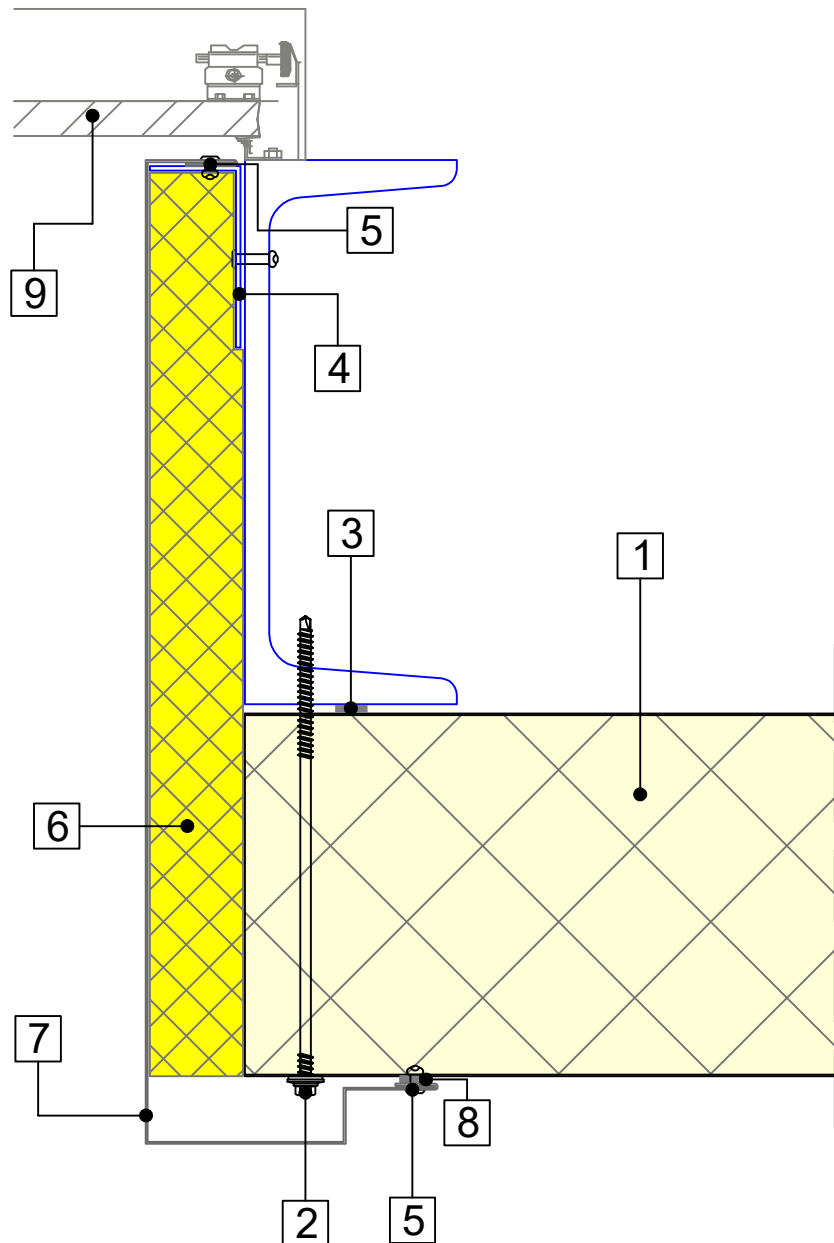

DAGKANT PROFIEL

$d \geq 0.60 \text{ mm}$



Nr.	Omschrijving	Schaal: 1:2.5
1	Sandwichpaneel	
2	Bevestigingsmiddel	
3	Zelfklevende afdichtingsband PE	
4	Stalen hoekje	
5	Popnagel	
6	Thermische isolatie	
7	Dagkant profiel	
8	Afdichtingsband PU	
9	Industriedeur; inbouw conform opgave leverancier	

GEVELS - VERTICALE MONTAGE
BUSINESS LINE ALPHA

G.CP.BL-V.07b
BOVENDETAIL INDUSTRIEDEUR
Horizontale doorsnede

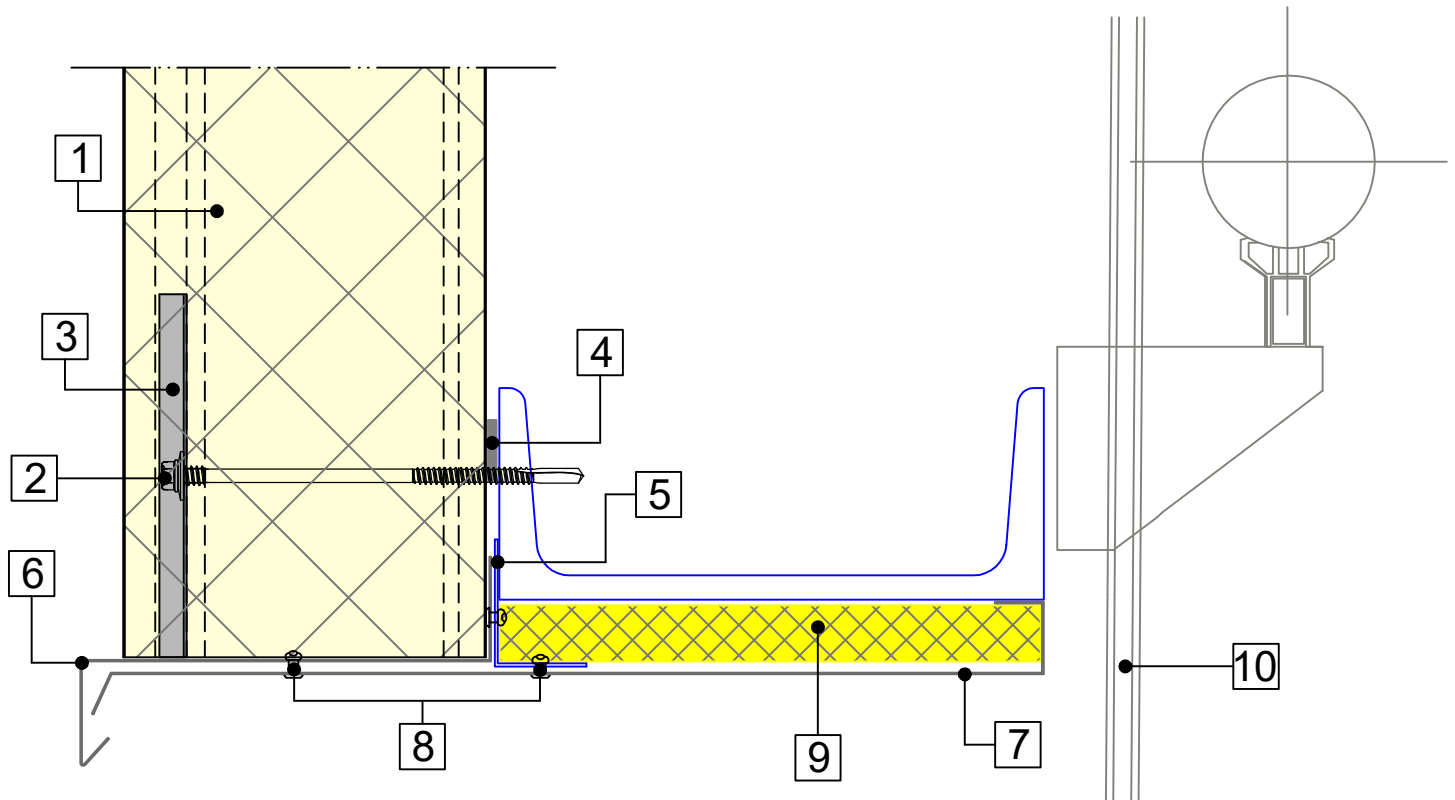

DRUKVERDEELPLAAT

*afm. 120*31*9*1.5 mm*



DEUR PROFIEL

d ≥ 0.60 mm



DAGKANT PROFIEL

d ≥ 0.60 mm



Nr.	Omschrijving	Schaal: 1:2.5
1	Sandwichpaneel	
2	Bevestigingsmiddel	
3	Drukverdeelplaat	
4	Zelfklevende afdichtingsband PE	
5	Stalen hoekje	
6	Deur profiel	
7	Dagkant profiel	
8	Popnagel	
9	Thermische isolatie	
10	Industriedeur; inbouw conform opgave leverancier	

GEVELS - HORIZONTALE MONTAGE
BUSINESS LINE BETA KV

G.CP.BL-H.01a
ONDERDETAIL - VARIANT 1
Verticale doorsnede

LEKDORPEL

$d \geq 0.60 \text{ mm}$



PANEELDRAGER [LS-1]

$d = 2.00 \text{ mm}$

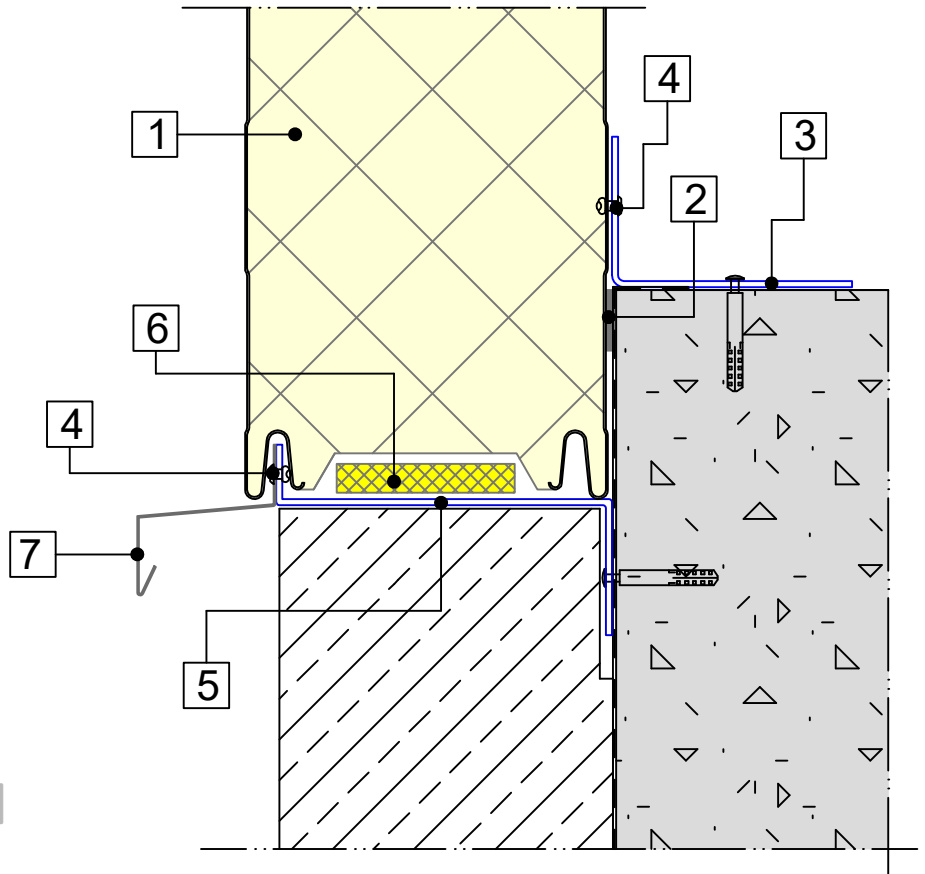

Nr.	Omschrijving	Schaal: 1:2.5
1	Sandwichpaneel	
2	Zelfklevende afdichtingsband PE	
3	Stalen binnenhoek	
4	Popnagel	
5	Paneeldrager	
6	Thermische isolatie	
7	Lekdorpel	

GEVELS - HORIZONTALE MONTAGE
BUSINESS LINE BETA KV

G.CP.BL-H.01b
ONDERDETAIL - VARIANT 2
Verticale doorsnede

STOOTPROFIEL*

$d \geq 0.60 \text{ mm}$



LEKDORPEL

$d \geq 0.60 \text{ mm}$



PANEELDRAGER [LS-3]

$d = 2.00 \text{ mm}$

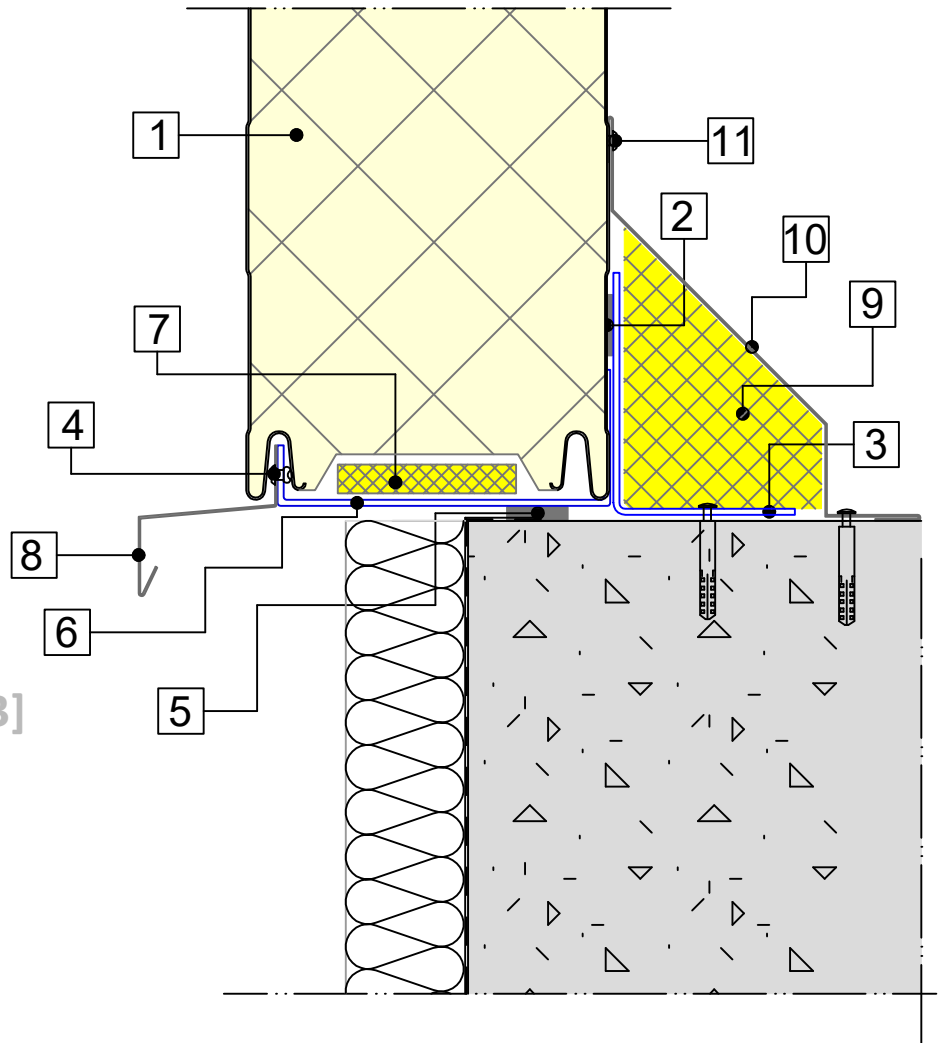

Nr.	Omschrijving	Schaal: 1:2.5
1	Sandwichpaneel	
2	Zelfklevende afdichtingsband PE	
3	Stalen binnenhoek	
4	Popnagel	
5	PU afdichtingsband	
6	Paneeldrager	
7	Thermische isolatie	
8	Lekdorpel	
9	Thermische isolatie*	
10	Stootprofiel*	
11	Popnagel*	

* Optioneel

GEVELS - HORIZONTALE MONTAGE
BUSINESS LINE ALPHA

G.CP.BL-H.01c
ONDERDETAIL - VARIANT 3
Verticale doorsnede

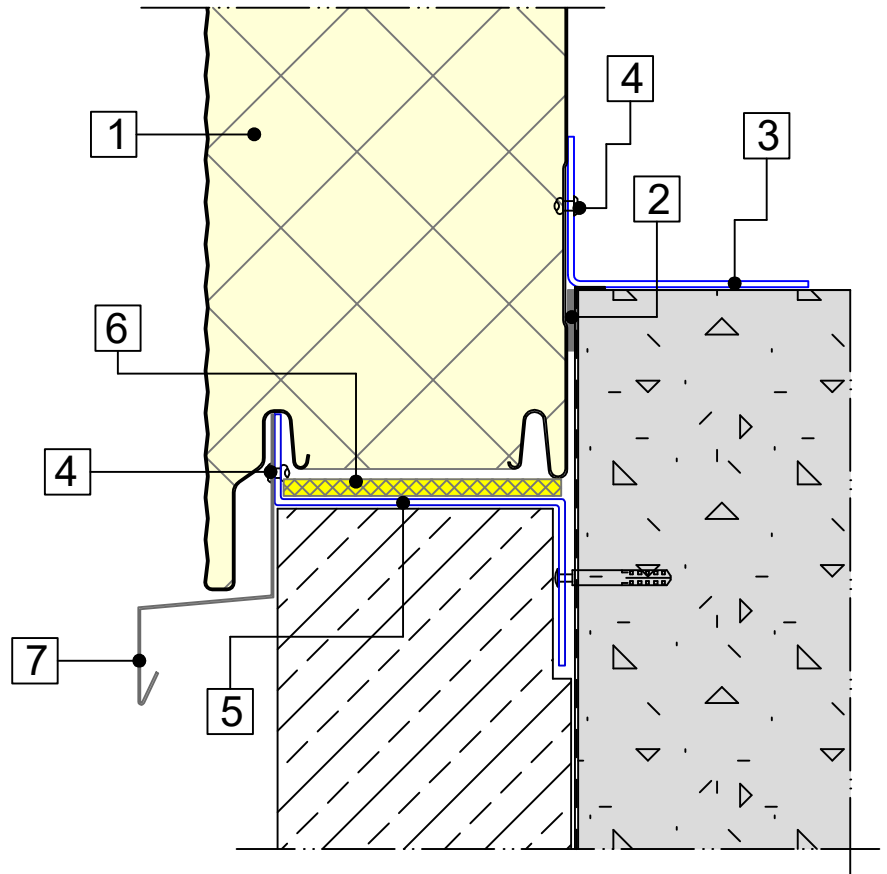

LEKDORPEL

$d \geq 0.60 \text{ mm}$



PANEELDRAGER [LS-2]

$d = 2.00 \text{ mm}$



Nr.	Omschrijving	Schaal: 1:2.5
1	Sandwichpaneel	
2	Zelfklevende afdichtingsband PE	
3	Stalen binnenhoek	
4	Popnagel	
5	Paneeldrager	
6	Thermische isolatie	
7	Lekdorpel	

GEVELS - HORIZONTALE MONTAGE
BUSINESS LINE ALPHA

G.CP.BL-H.01d
ONDERDETAIL - VARIANT 4
Verticale doorsnede

STOOTPROFIEL*

$d \geq 0.60 \text{ mm}$



PANEELDRAGER [LS-4]

$d = 2.00 \text{ mm}$

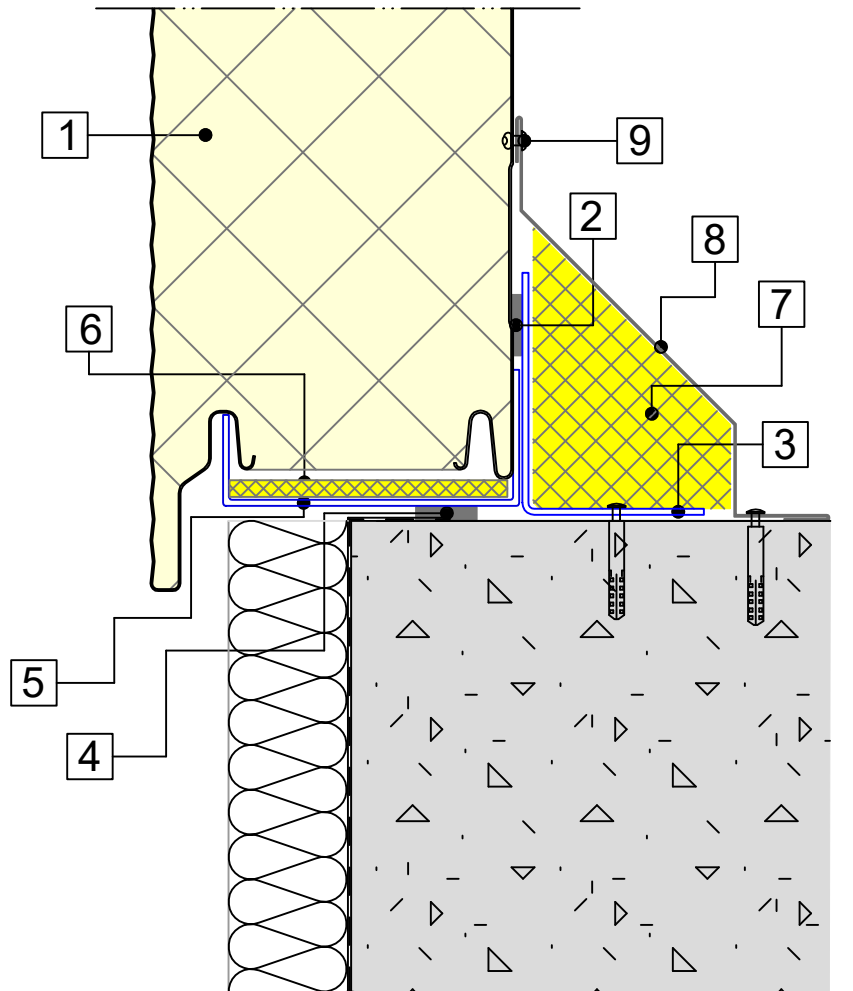

Nr.	Omschrijving	Schaal: 1:2.5
1	Sandwichpaneel	
2	Zelfklevende afdichtingsband PE	
3	Stalen binnenhoek	
4	PU afdichtingsband	
5	Paneeldrager	
6	Thermische isolatie	
7	Thermische isolatie*	
8	Stootprofiel*	
9	Popnagel*	
	* <i>Optioneel</i>	

GEVELS - HORIZONTALE MONTAGE
BUSINESS LINE BETA KV

G.CP.BL-H.02a
ZICHTBARE BEVESTIGING

Horizontale doorsnede

Verticale doorsnede

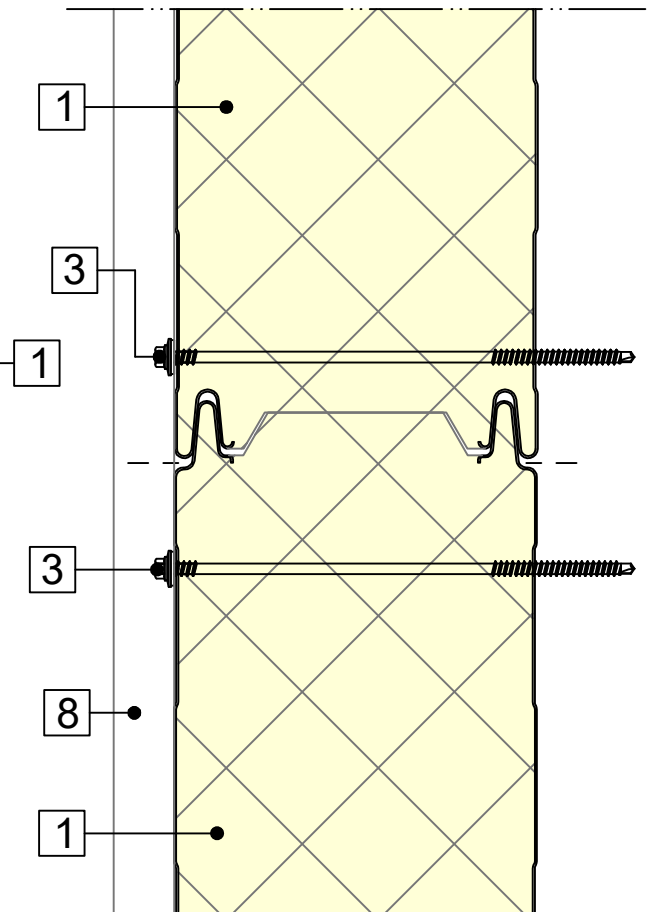
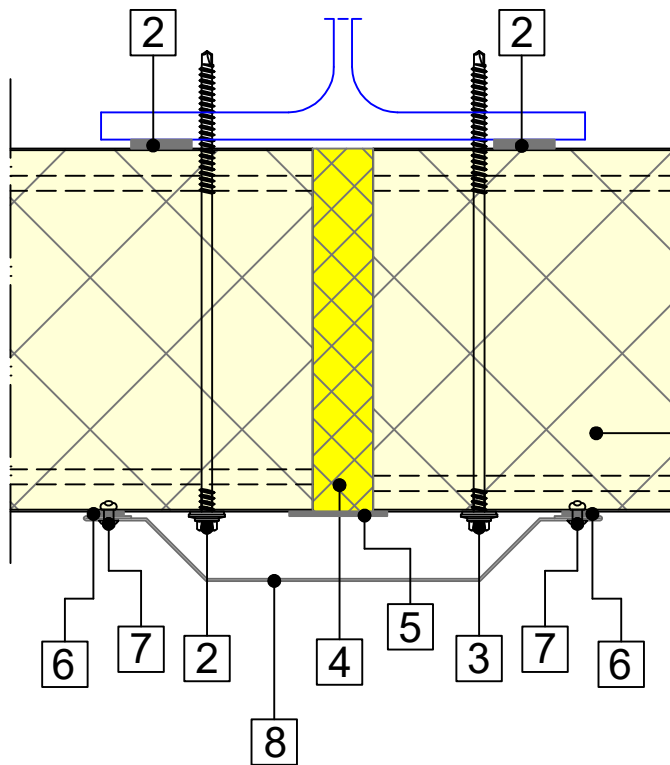

AFDEKPROFIEL [A]

$d \geq 0.60 \text{ mm}$



Nr.	Omschrijving	Schaal: 1:2.5
1	Sandwichpaneel	
2	Zelfklevende afdichtingsband PE	
3	Bevestigingsmiddel	
4	Thermische isolatie	
5	Dampscherm Aluminium butyl tape	
6	Afdichtingsband	
7	Popnagel	
8	Stuiknaad profiel	

GEVELS - HORIZONTALE MONTAGE
BUSINESS LINE BETA KV

G.CP.BL-H.02b
 VOEGAANSLUITING

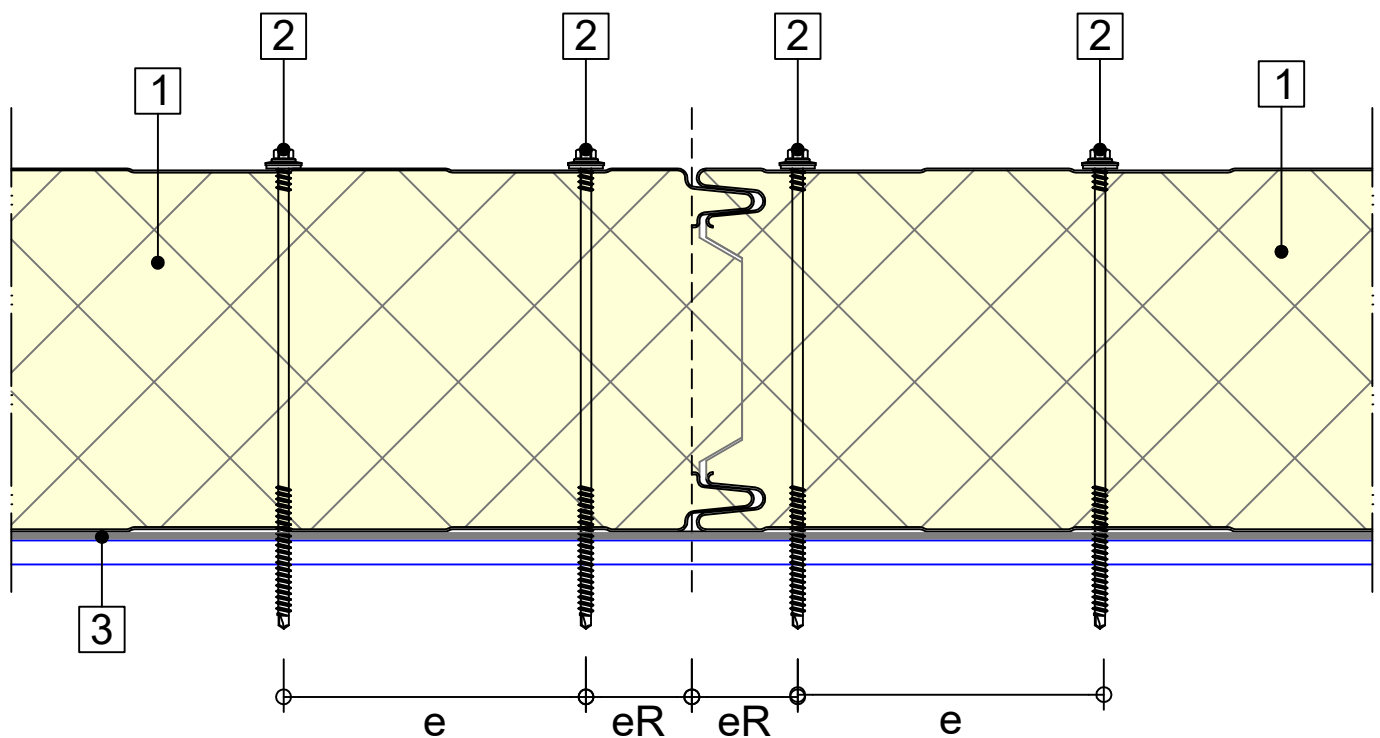

Schroefafstanden	Onderlinge afstand	Vanaf paneelrand [eR]
Loodrecht op montagerichting (zie afbeelding)	≥ 100 mm	≥ 35 mm
Parallel aan montagerichting	H.o.h. afstand ondersteuning	≥ 20 mm & ≥ 3d
d: Schroefdiameter		

Omschrijving

Schaal: 1:2.5

Sandwichpaneel

Bevestigingsmiddel

Zelfklevende afdichtingsband PE

GEVELS - HORIZONTALE MONTAGE
BUSINESS LINE ALPHA

G.CP.BL-H.02c
VERDEKTE BEVESTIGING

Horizontale doorsnede

Verticale doorsnede

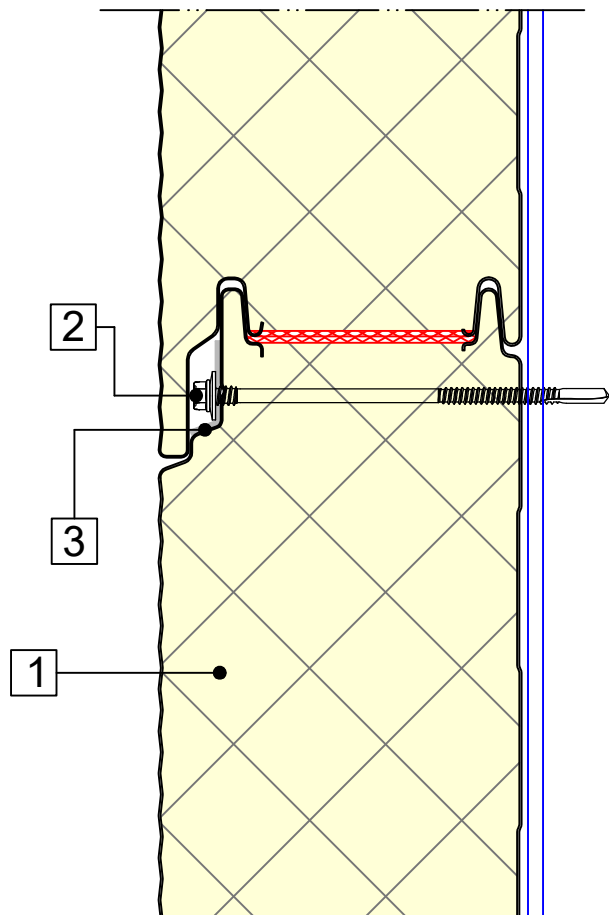
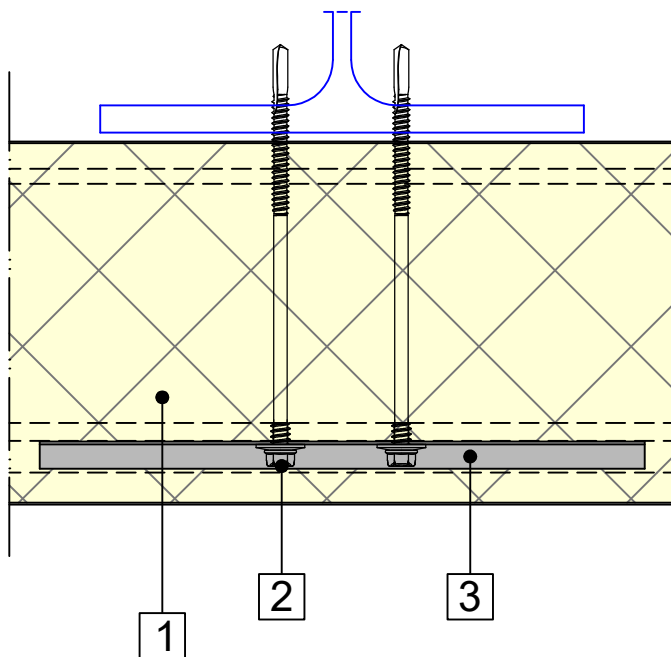

DRUKVERDEELPLAAT

afm. 200*31*9*1.5 mm



Nr.	Omschrijving	Schaal: 1:2.5
1	Sandwichpaneel	
2	Bevestigingsmiddel	
3	Drukverdeelplaat	

GEVELS - HORIZONTALE MONTAGE
BUSINESS LINE BETA KV

G.CP.BL-H.03a
DAKRAND DETAIL - VARIANT 1
Verticale doorsnede

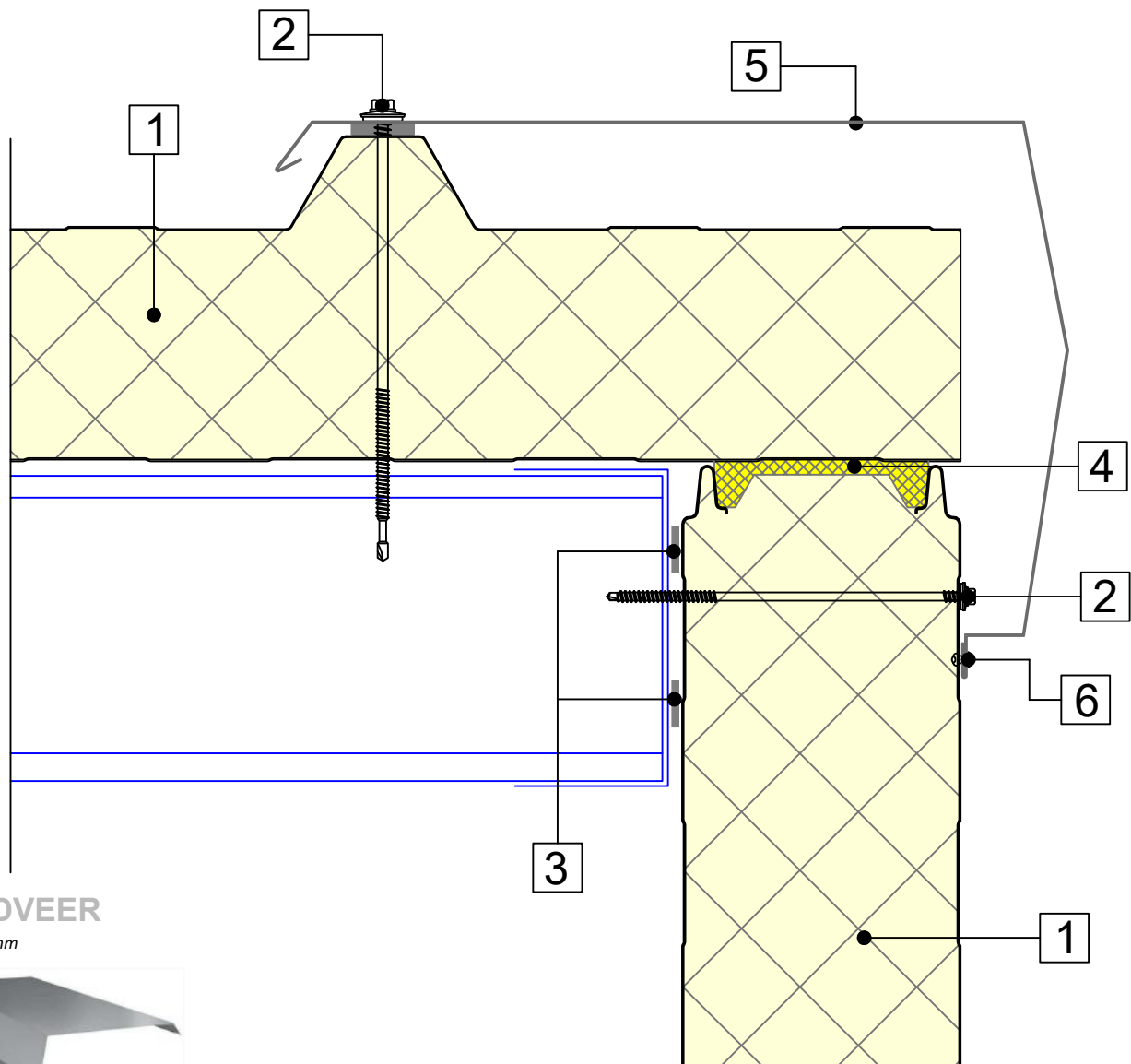

WINDVEER

$d \geq 0.60 \text{ mm}$



Nr.	Omschrijving	Schaal: 1:3
1	Sandwichpaneel	
2	Bevestigingsmiddel	
3	Zelfklevende afdichtingsband PE	
4	Thermische isolatie	
5	Zetwerk	
6	Popnagel	

GEVELS - HORIZONTALE MONTAGE
BUSINESS LINE BETA KV

G.CP.BL-H.03b
DAKRAND DETAIL - VARIANT 2
Verticale doorsnede

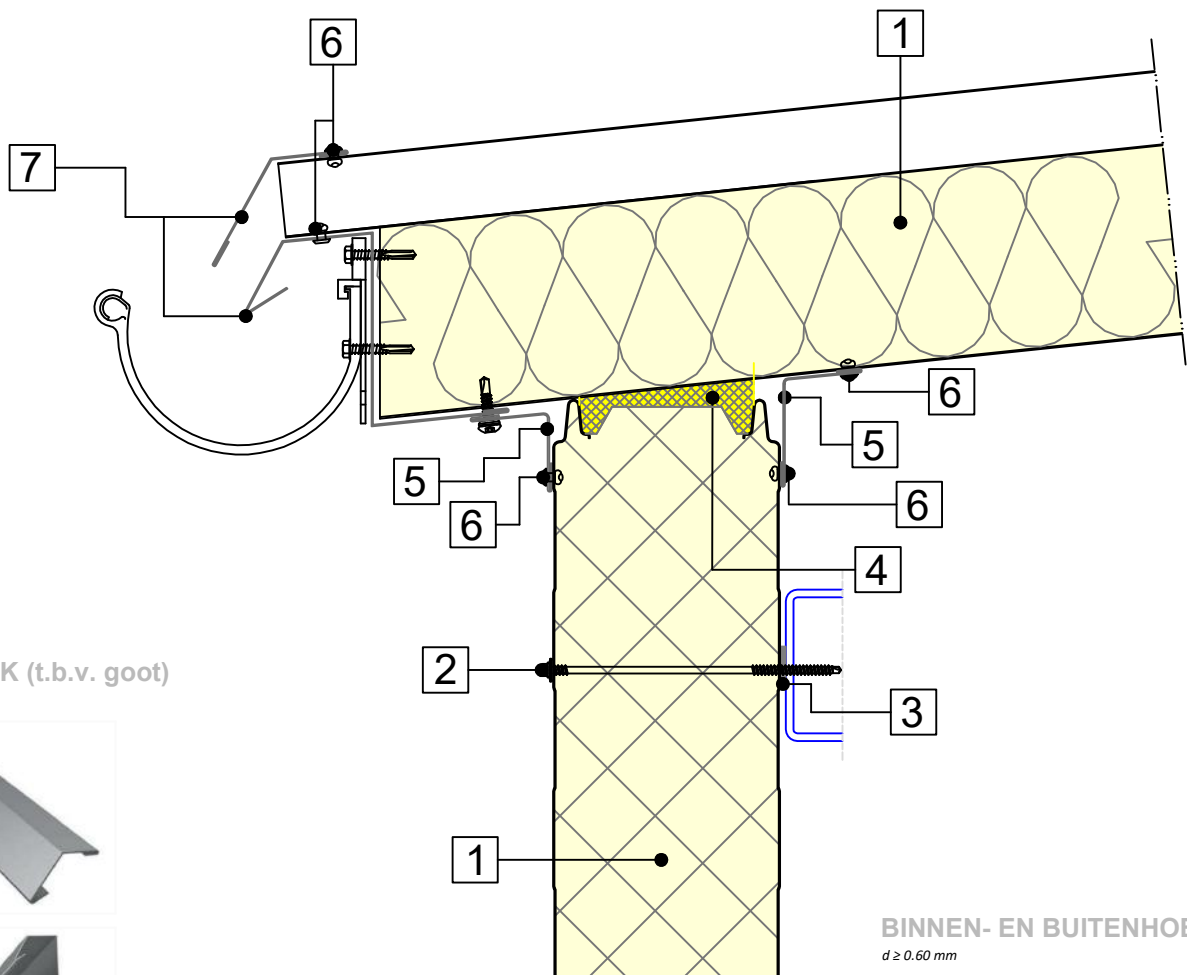

ZETWERK (t.b.v. goot)
 $d \geq 0.60 \text{ mm}$



BINNEN- EN BUITENHOEKJE
 $d \geq 0.60 \text{ mm}$



Nr.	Omschrijving	Schaal: 1:4
1	Sandwichpaneel	
2	Bevestigingsmiddel	
3	Zelfklevende afdichtingsband PE	
4	Thermische isolatie	
5	Stalen buiten/binnenhoekje	
6	Popnagel	
7	Stalen zetwerk t.b.v waterinloop goot	

GEVELS - HORIZONTALE MONTAGE
BUSINESS LINE BETA KV

G.CP.BL-H.03c
DAKRAND DETAIL - VARIANT 3
Verticale doorsnede

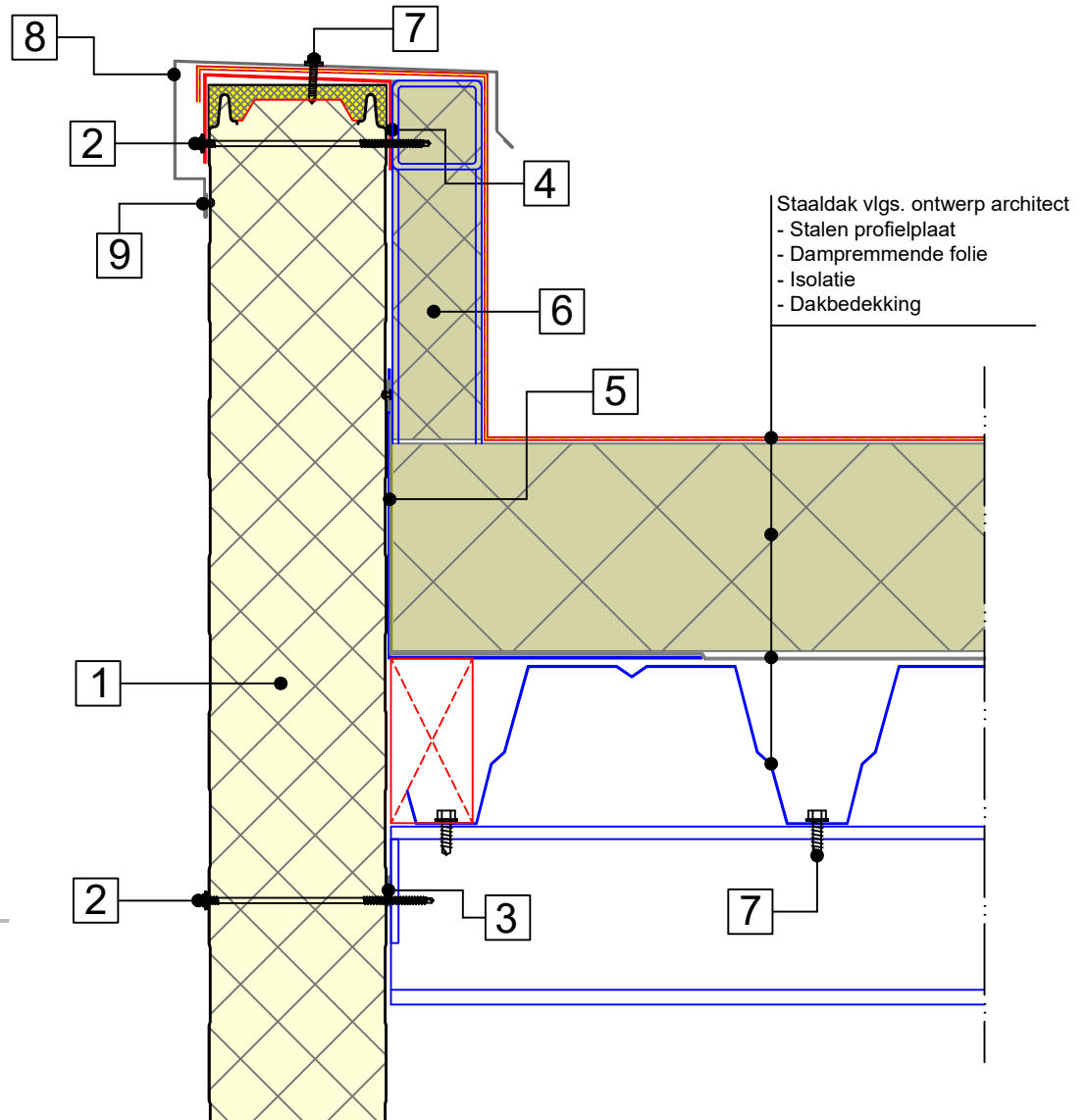

DAKRAND PROFIEL
 $d \geq 0.60 \text{ mm}$



Nr.	Omschrijving	Schaal: 1:5
1	Sandwichpaneel	
2	Bevestigingsmiddel	
3	Zelfklevende afdichtingsband PE	
4	U-profiel	
5	Haakse hoek	
6	Isolatie	
7	Bevestigingsmiddel	
8	Dakrand profiel	
9	Popnagel	

GEVELS - HORIZONTALE MONTAGE
BUSINESS LINE BETA KV

G.CP.BL-H.04a
STUIKNAAD - VARIANT 1
Horizontale doorsnede

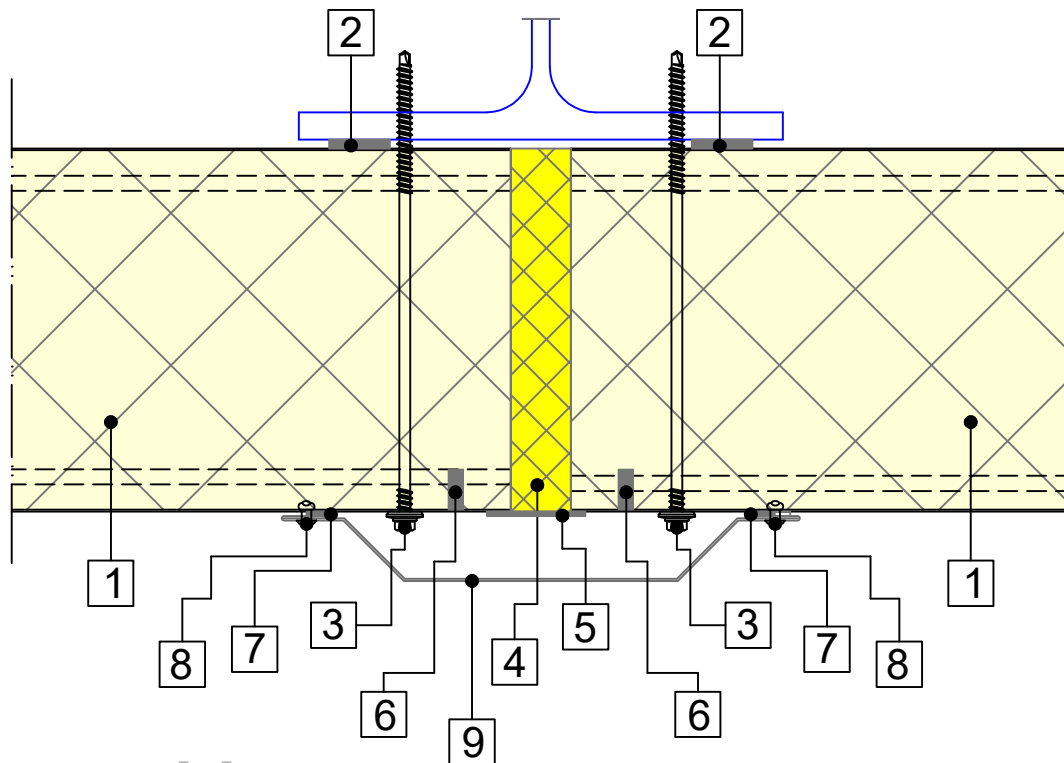

AFDEKPROFIEL [A]

$d \geq 0.60 \text{ mm}$



Nr.	Omschrijving	Schaal: 1:2.5
1	Sandwichpaneel	
2	Zelfklevende afdichtingsband PE	
3	Bevestigingsmiddel	
4	Thermische isolatie	
5	Dampscherm Aluminium butyl tape*	
6	Waterstop, silicone kit	
7	PU afdichtingsband	
8	Popnagel	
9	Afdekprofiel [A]	

* Optioneel

GEVELS - HORIZONTALE MONTAGE
BUSINESS LINE BETA KV

G.CP.BL-H.04b
STUIKNAAD - VARIANT 2
Horizontale doorsnede

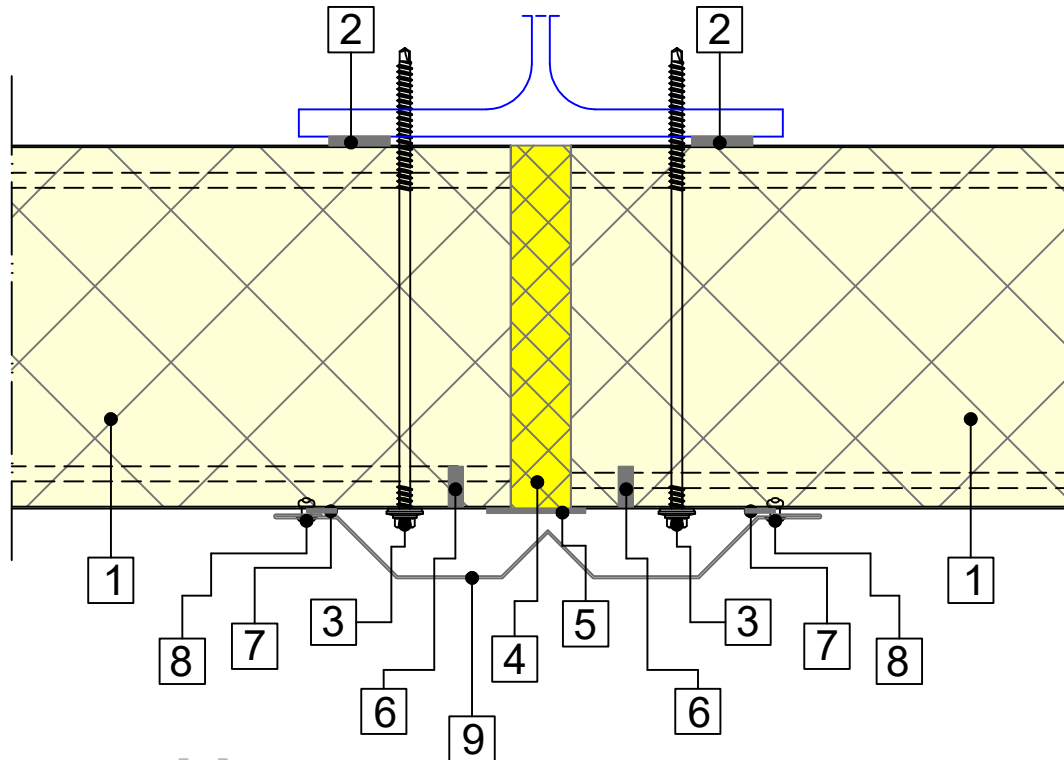

AFDEKPROFIEL [C]

$d \geq 0.60 \text{ mm}$



Nr.	Omschrijving	Schaal: 1:2.5
1	Sandwichpaneel	
2	Zelfklevende afdichtingsband PE	
3	Bevestigingsmiddel	
4	Thermische isolatie	
5	Dampscherm Aluminium butyl tape*	
6	Waterstop, silicone kit	
7	PU afdichtingsband	
8	Popnagel	
9	Afdekprofiel [C]	

* Optioneel

GEVELS - HORIZONTALE MONTAGE
BUSINESS LINE ALPHA

G.CP.BL-H.04c
STUIKNAAD - VARIANT 3
Horizontale doorsnede

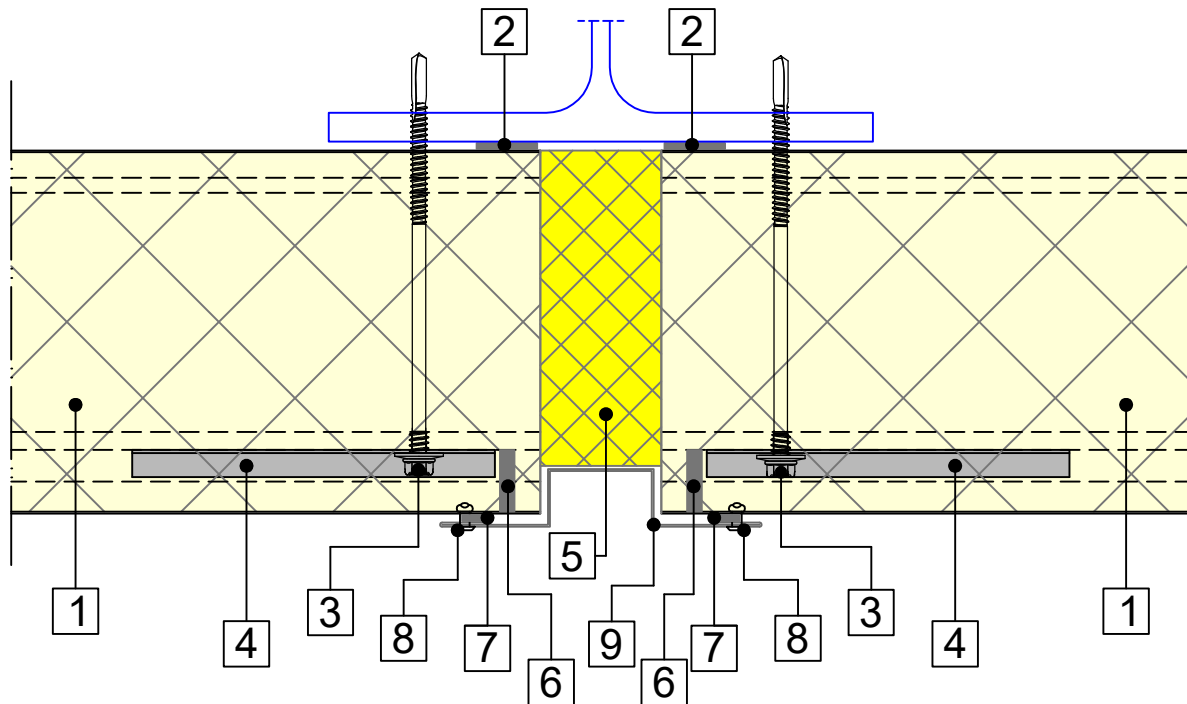

AFDEKPROFIEL [B]

$d \geq 0.60 \text{ mm}$



DRUKVERDEELPLAAT

*afm. 120*31*9*1.5 mm*



Nr.	Omschrijving	Schaal: 1:2.5
1	Sandwichpaneel	
2	Zelfklevende afdichtingsband PE	
3	Bevestigingsmiddel	
4	Drukverdeelplaat	
5	Thermische isolatie	
6	Waterstop, silicone kit	
7	PU afdichtingsband	
8	Popnagel	
9	Afdekprofiel [B]	

GEVELS - HORIZONTALE MONTAGE
BUSINESS LINE ALPHA

G.CP.BL-H.04d
STUIKNAAD - VARIANT 4
Horizontale doorsnede

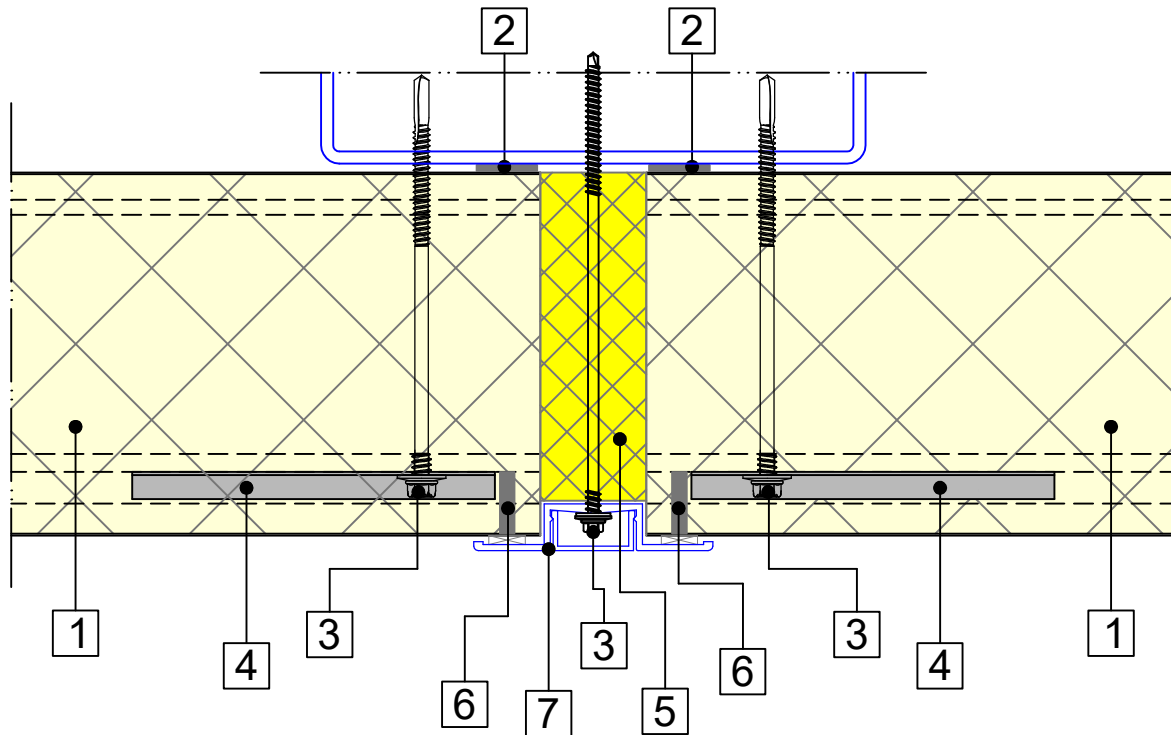

AFDEKPROFIEL [D]

$d \geq 0.60 \text{ mm}$

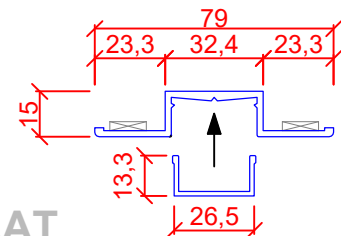
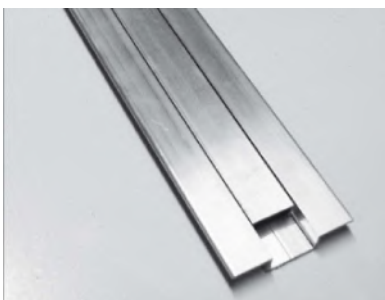

DRUKVERDEELPLAAT

afm. 120*31*9*1.5 mm



Nr.	Omschrijving	Schaal: 1:2.5
1	Sandwichpaneel	
2	Zelfklevende afdichtingsband PE	
3	Bevestigingsmiddel	
4	Drukverdeelplaat	
5	Thermische isolatie	
6	Waterstop, silicone kit	
7	Afdekprofiel [D]	

GEVELS - HORIZONTALE MONTAGE
BUSINESS LINE BETA KV

G.CP.BL-H.05a
UITWENDIGE HOEK - VARIANT 1
Horizontale doorsnede

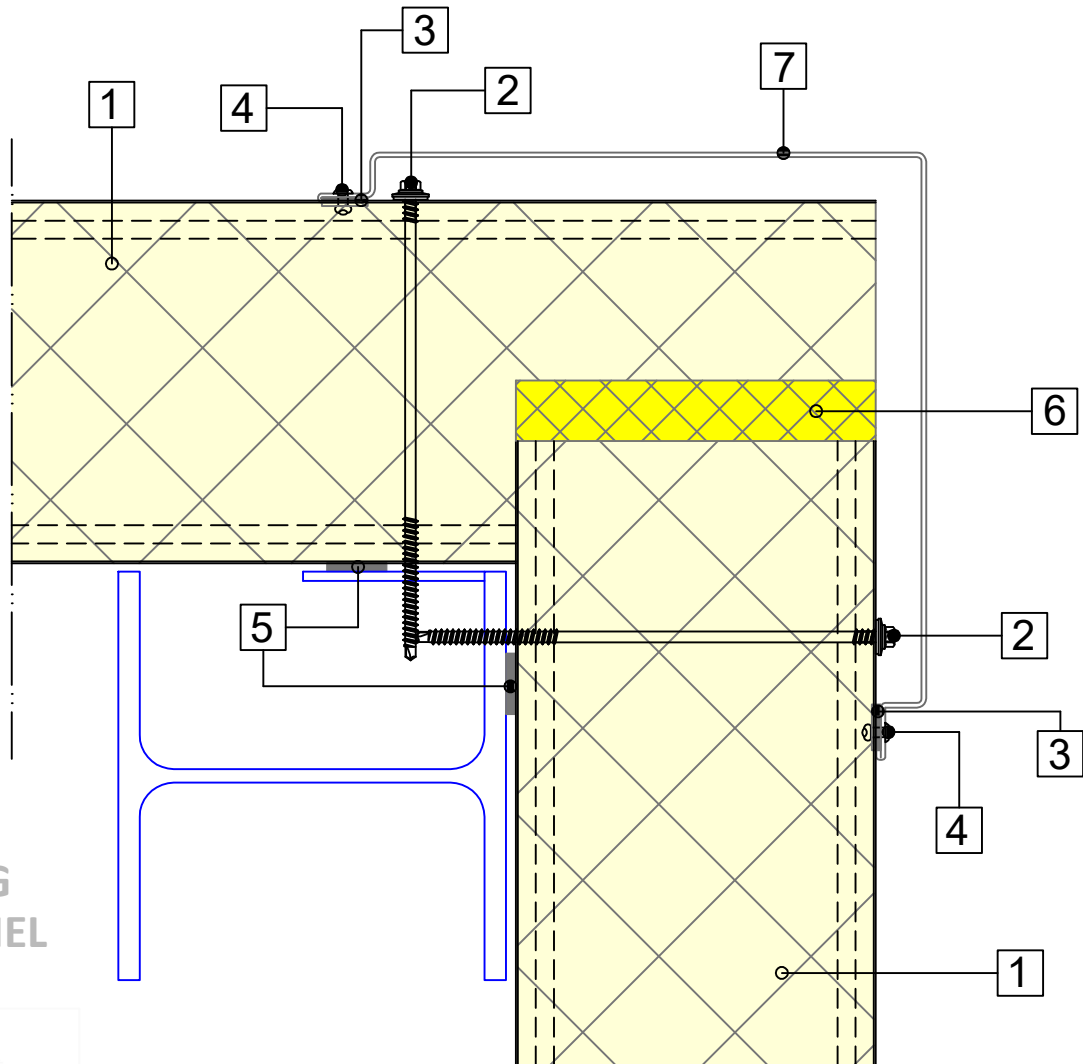

**UITWENDIG
HOEKPROFIEL**

$d \geq 0.60 \text{ mm}$



Nr.	Omschrijving	Schaal: 1:2.5
1	Sandwichpaneel	
2	Bevestigingsmiddel	
3	Zelfklevende afdichtingsband EPDM	
4	Popnagel	
5	Zelfklevende afdichtingsband PE	
6	Thermische isolatie	
7	Uitwendig hoekprofiel	

GEVELS - HORIZONTALE MONTAGE
BUSINESS LINE BETA KV

G.CP.BL-H.05b
UITWENDIGE HOEK - VARIANT 2
Horizontale doorsnede

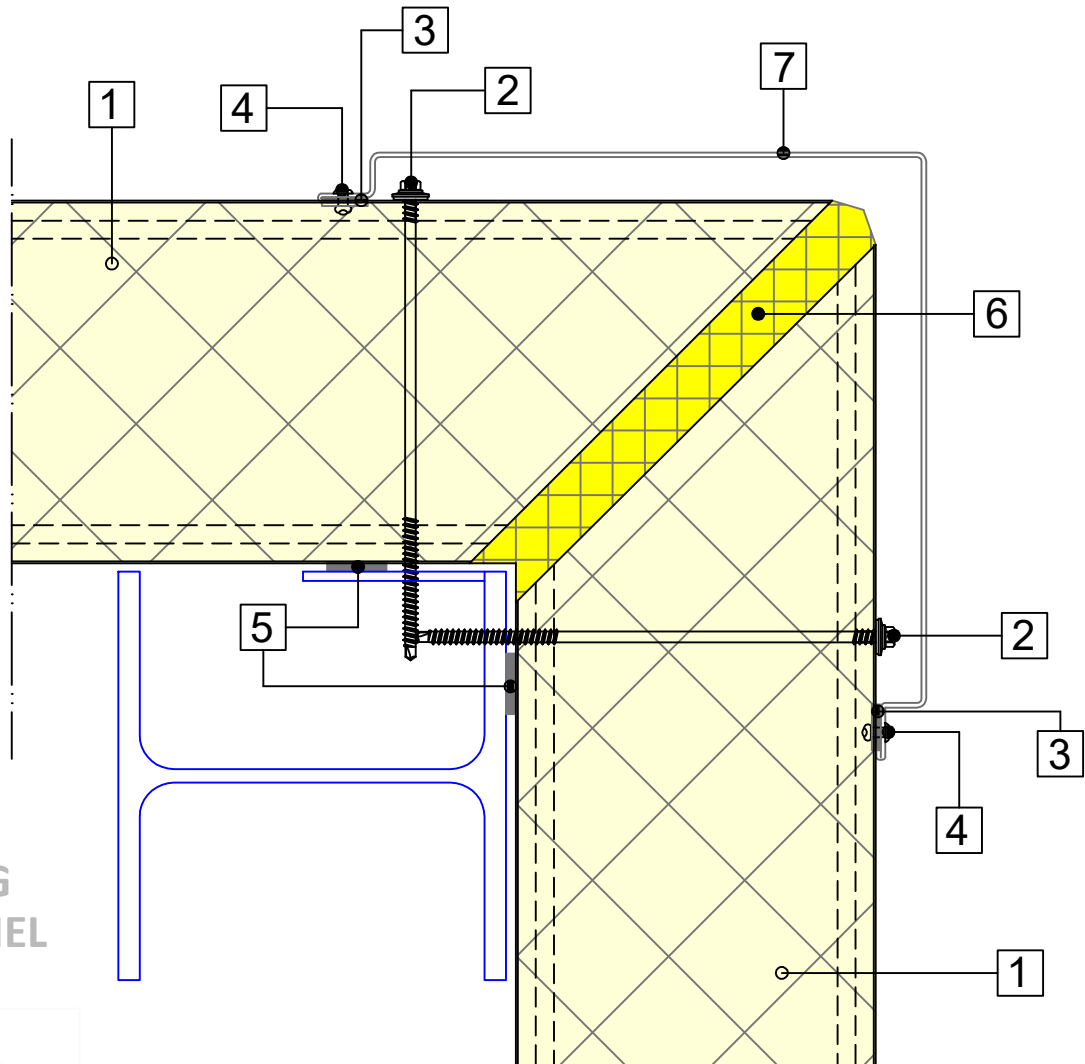

**UITWENDIG
HOEKPROFIEL**

$d \geq 0.60 \text{ mm}$



Nr.	Omschrijving	Schaal: 1:2.5
1	Sandwichpaneel	
2	Bevestigingsmiddel	
3	Zelfklevende afdichtingsband EPDM	
4	Popnagel	
5	Zelfklevende afdichtingsband PE	
6	Thermische isolatie	
7	Uitwendig hoekprofiel	

GEVELS - HORIZONTALE MONTAGE
BUSINESS LINE BETA KV

G.CP.BL-H.05c
PREFAB HOEK
Horizontale doorsnede

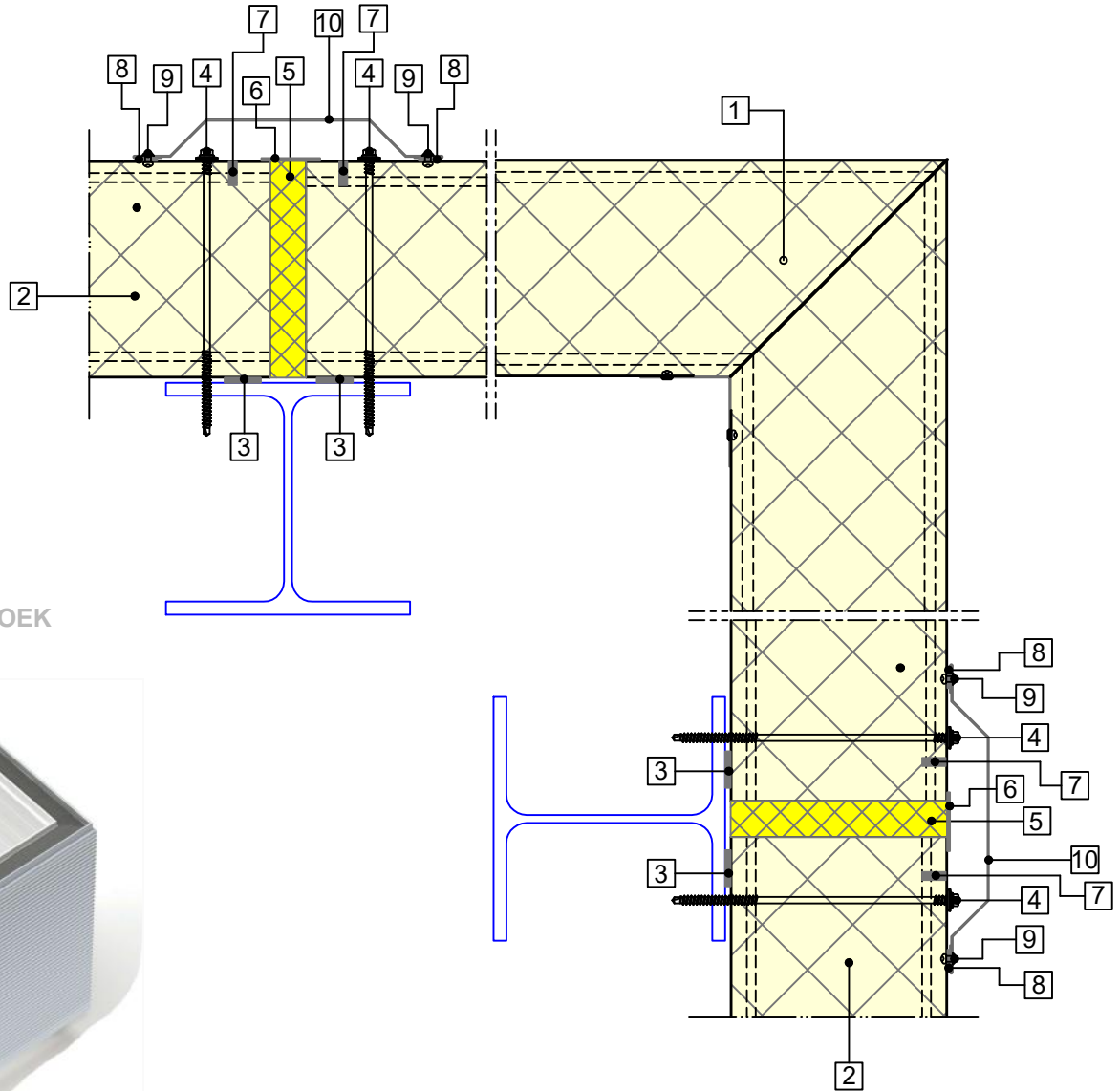

PREFAB HOEK
Horizontaal - 90°

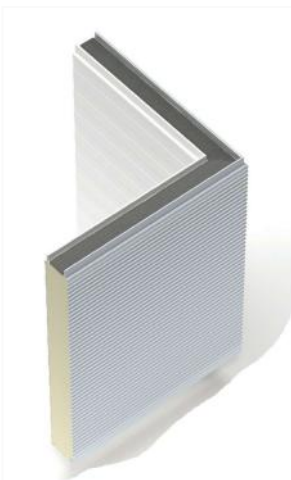

Nr.	Omschrijving	Schaal: 1:4
1	Prefab hoek 90°	
2	Sandwichpaneel	
3	Zelfklevende afdichtingsband PE	
4	Bevestigingsmiddel	
5	Thermische isolatie	
6	Dampscherm, aluminium butyl tape*	
7	Waterstop, silicone kit	
8	Afdichtingsband PU	
9	Popnagel	
10	Afdekprofiel [A]	

GEVELS - HORIZONTALE MONTAGE
BUSINESS LINE BETA KV

G.CP.BL-H.06a
INWENDIGE HOEK
Horizontale doorsnede

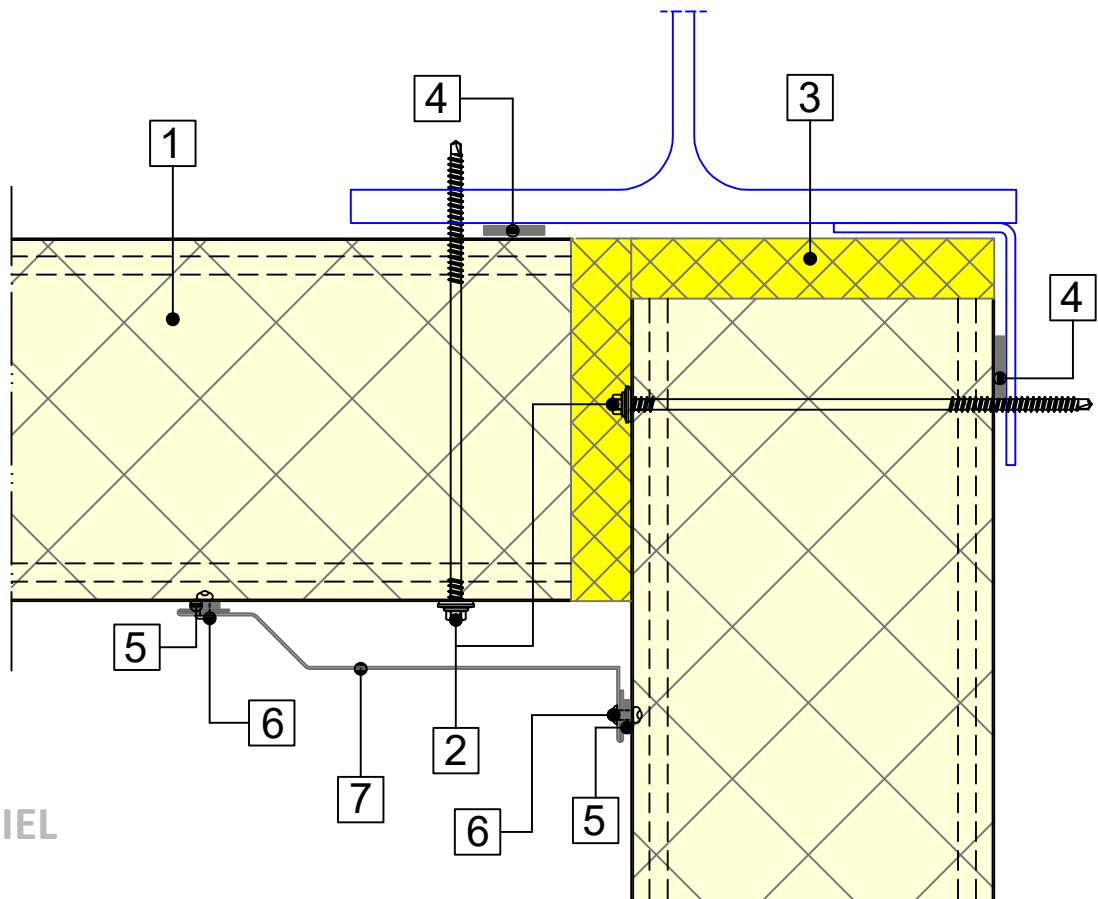

**INWENDIG
HOEKPROFIEL**

$d \geq 0.60 \text{ mm}$



Nr.	Omschrijving	Schaal: 1:2.5
1	Sandwichpaneel	
2	Bevestigingsmiddel	
3	Thermische isolatie	
4	Zelfklevende afdichtingsband PE	
5	Afdichtingsband	
6	Popnagel	
7	Inwendig hoekprofiel	

GEVELS - HORIZONTALE MONTAGE
BUSINESS LINE BETA KV

G.CP.BL-H.07a
BOVENDETAIL KOZIJN
Verticale doorsnede

**ONDERPROFIEL
LEKDORPEL**

$d \geq 0.60 \text{ mm}$



LEKDORPEL

$d \geq 0.60 \text{ mm}$

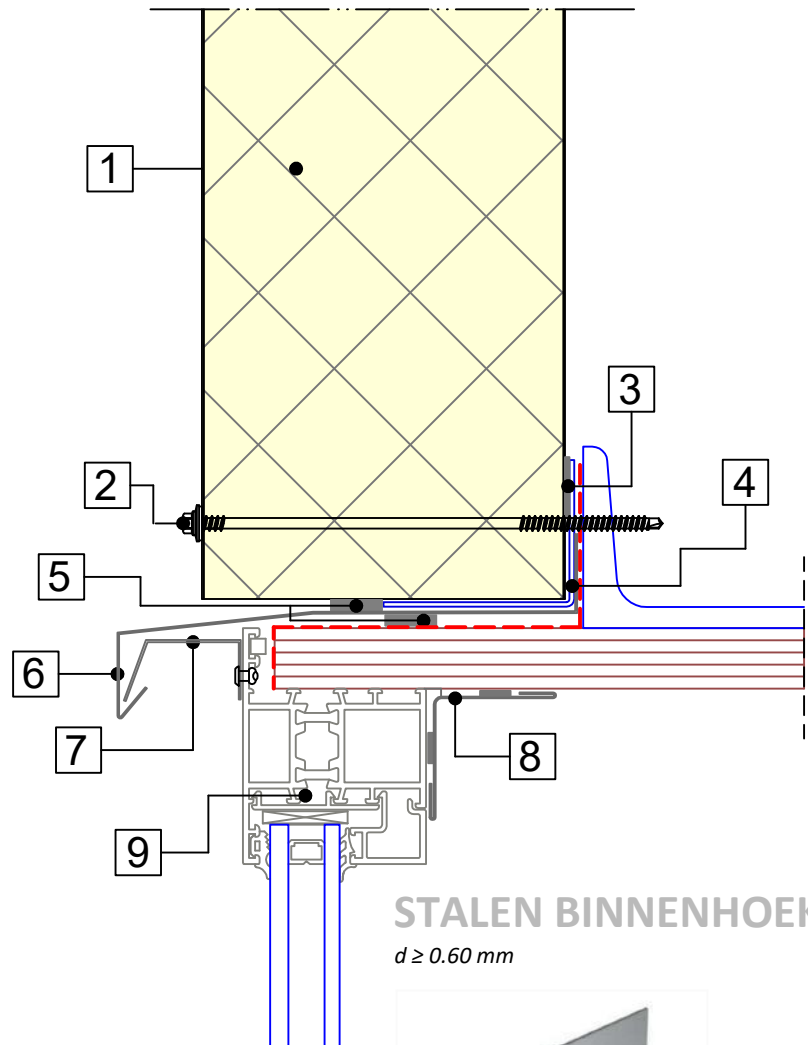

STALEN BINNENHOEK
 $d \geq 0.60 \text{ mm}$



Nr.	Omschrijving	Schaal: 1:2.5
1	Sandwichpaneel	
2	Bevestigingsmiddel	
3	Zelfklevende afdichtingsband PE	
4	Paneeldrager	
5	Afdichtingsband PU	
6	Lekdorpel	
7	Onderdorpel	
8	Stalen binnenhoek	
9	Kozijn; inbouw conform opgave leverancier	

GEVELS - HORIZONTALE MONTAGE
BUSINESS LINE BETA KV

G.CP.BL-H.07b
ONDERDETAIL KOZIJN
Verticale doorsnede

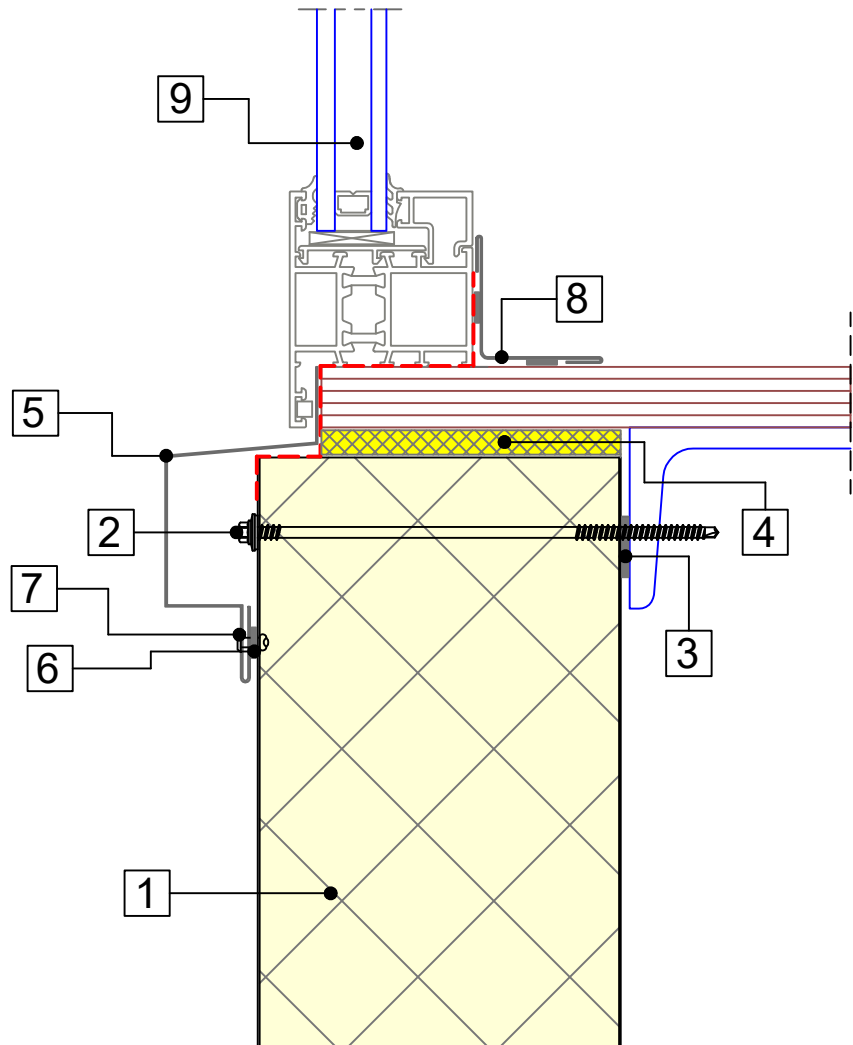

STALEN BINNENHOEK

$d \geq 0.60 \text{ mm}$



RAAMDORPEL

$d \geq 0.60 \text{ mm}$



Nr.	Omschrijving	Schaal: 1:2.5
1	Sandwichpaneel	
2	Bevestigingsmiddel	
3	Zelfklevende afdichtingsband PE	
4	Thermische isolatie	
5	Raamdorpel	
6	Afdichtingsband	
7	Popnagel	
8	Stalen binnenhoek	
9	Kozijn; inbouw conform opgave leverancier	

GEVELS - HORIZONTALE MONTAGE
BUSINESS LINE BETA KV

G.CP.BL-H.07c
DAGKANT KOZIJN
Horizontale doorsnede

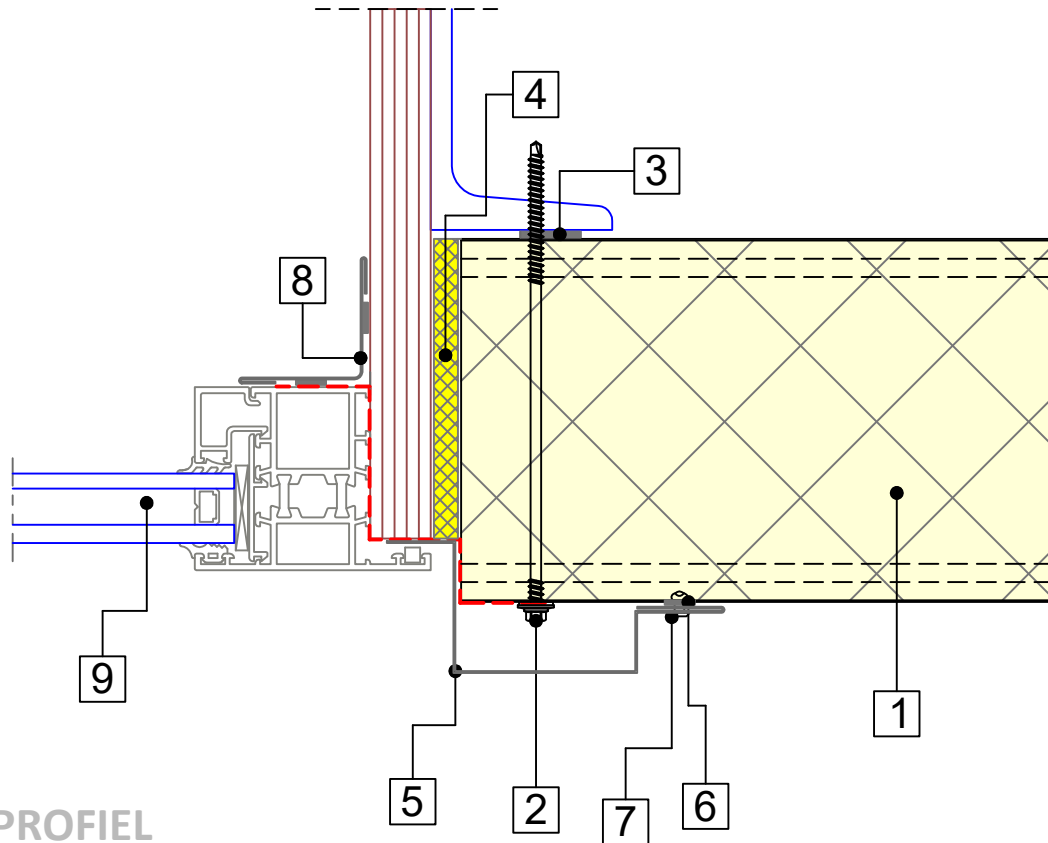

DAGKANT PROFIEL

$d \geq 0.60 \text{ mm}$



STALEN BINNENHOEK

$d \geq 0.60 \text{ mm}$



Nr.	Omschrijving	Schaal: 1:2.5
1	Sandwichpaneel	
2	Bevestigingsmiddel	
3	Zelfklevende afdichtingsband PE	
4	Thermische isolatie	
5	Dagkantprofiel	
6	Afdichtingsband PU	
7	Popnagel	
8	Stalen binnenhoek	
9	Kozijn; inbouw conform opgave leverancier	

GEVELS - HORIZONTALE MONTAGE
BUSINESS LINE BETA KV

G.CP.BL-H.07d
KLEMKOZIJN
Horizontale doorsnede

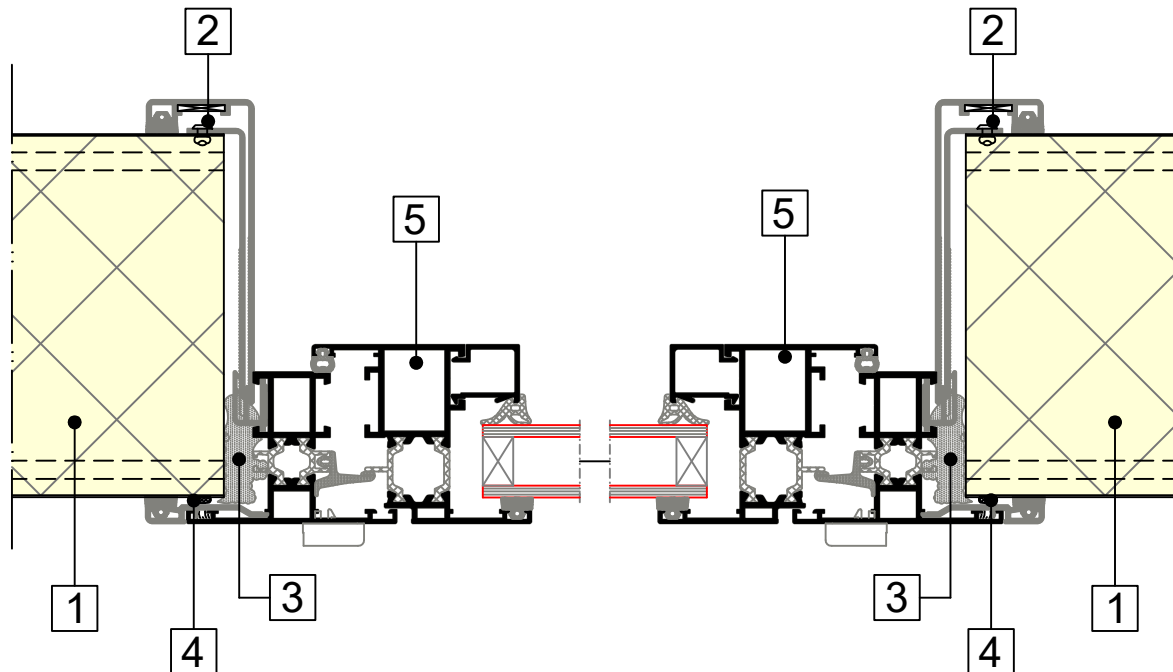

CASTELLUM KOZIJN

Inbouw conform opgave Primoclad Europe.
www.primoclad.nl



Nr.	Omschrijving	Schaal: 1:2.5
1	Sandwichpaneel	
2	Popnagel	
3	PUR-schuim	
4	Siliconen butyleen kit	
5	Raam Castellum [59S]; inbouw conform opgave leverancier	

GEVELS - HORIZONTALE MONTAGE
BUSINESS LINE BETA KV

G.CP.BL-H.07e
KLEMKOZIJN
Verticale doorsnede

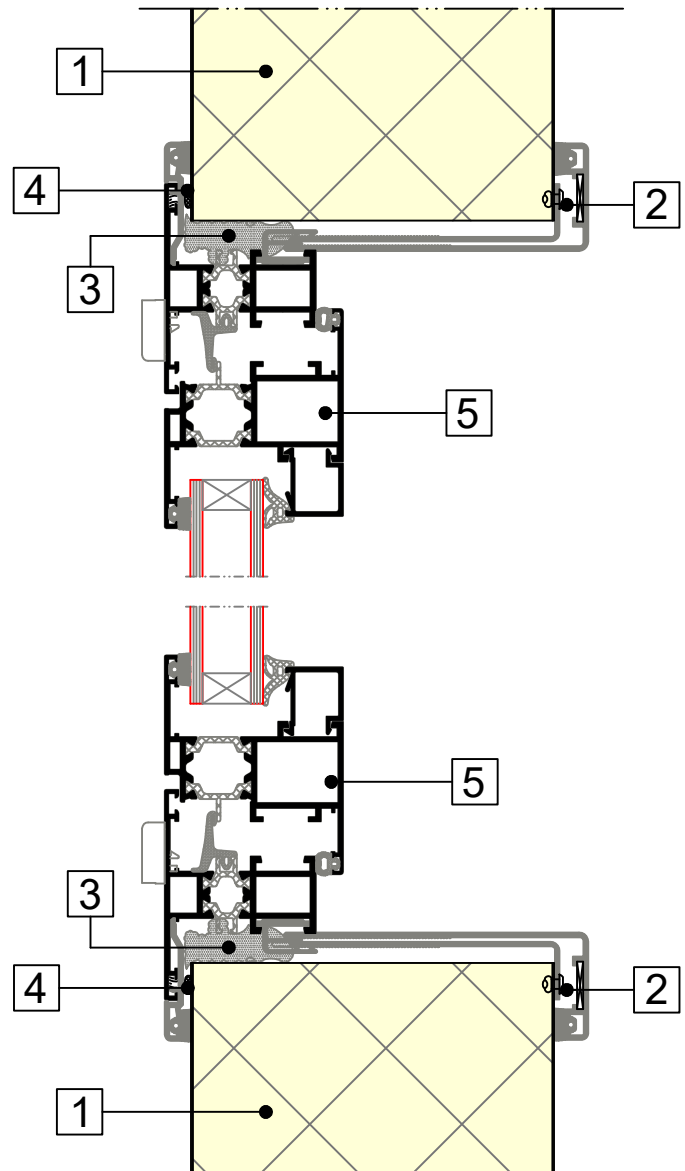

CASTELLUM KOZIJN

Inbouw conform opgave Primoclad Europe.
www.primoclad.nl



Nr.	Omschrijving	Schaal: 1:2.5
1	Sandwichpaneel	
2	Popnagel	
3	PUR-schuim	
4	Siliconen butyleen kit	
5	Raam Castellum [59S]; inbouw conform opgave leverancier	

GEVELS - HORIZONTALE MONTAGE
BUSINESS LINE BETA KV

G.CP.BL-H.07f
KLEMKOZIJN DEUR

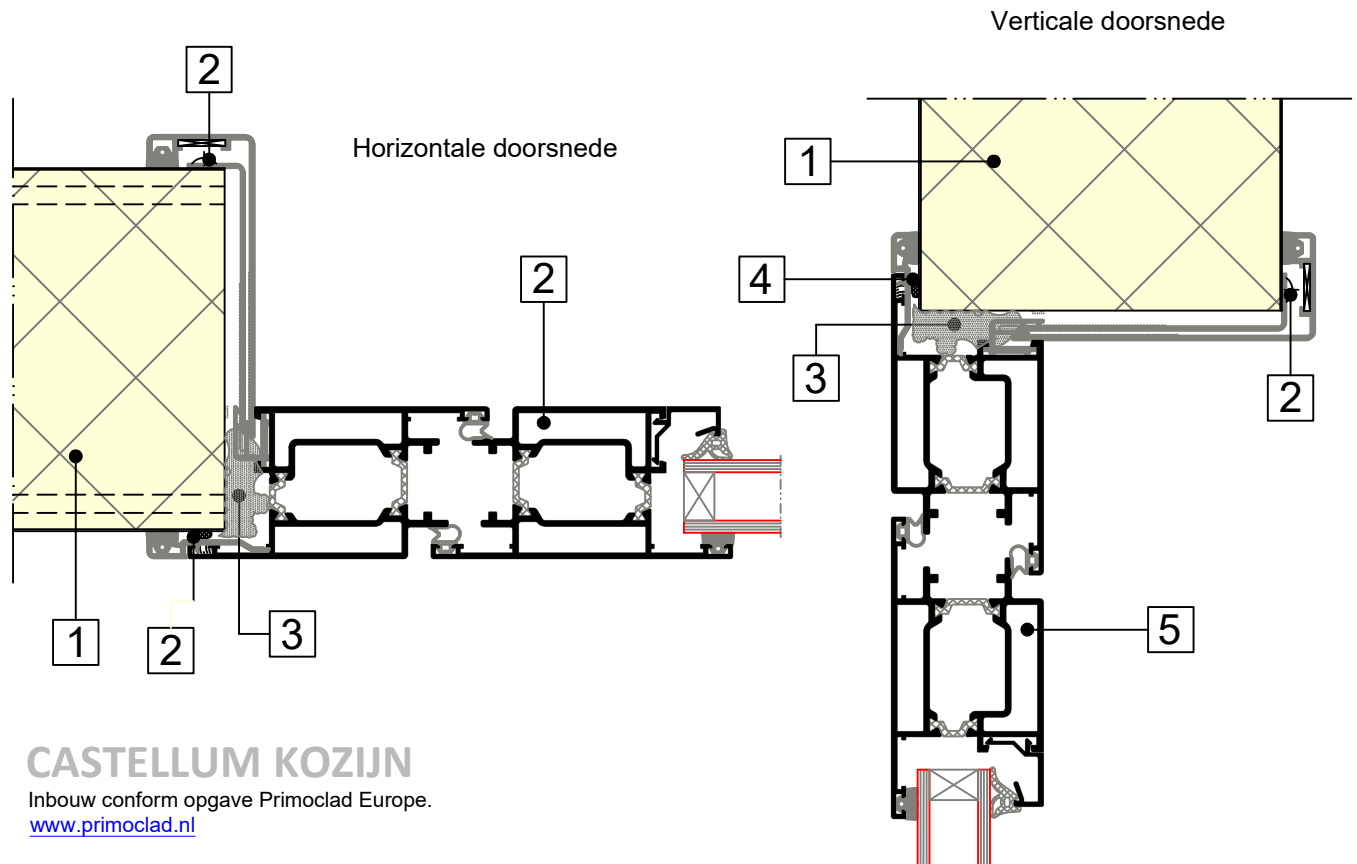

CASTELLUM KOZIJN

Inbouw conform opgave Primoclad Europe.
www.primoclad.nl



Nr.	Omschrijving	Schaal: 1:2.5
1	Sandwichpaneel	
2	Popnagel	
3	PUR-schuim	
4	Siliconen butyleen kit	
5	Deur Castellum [59S]; inbouw conform opgave leverancier	

GEVELS - HORIZONTALE MONTAGE
BUSINESS LINE BETA KV

G.CP.BL-H.08a
DAGKANT INDUSTRIEDEUR
Horizontale doorsnede

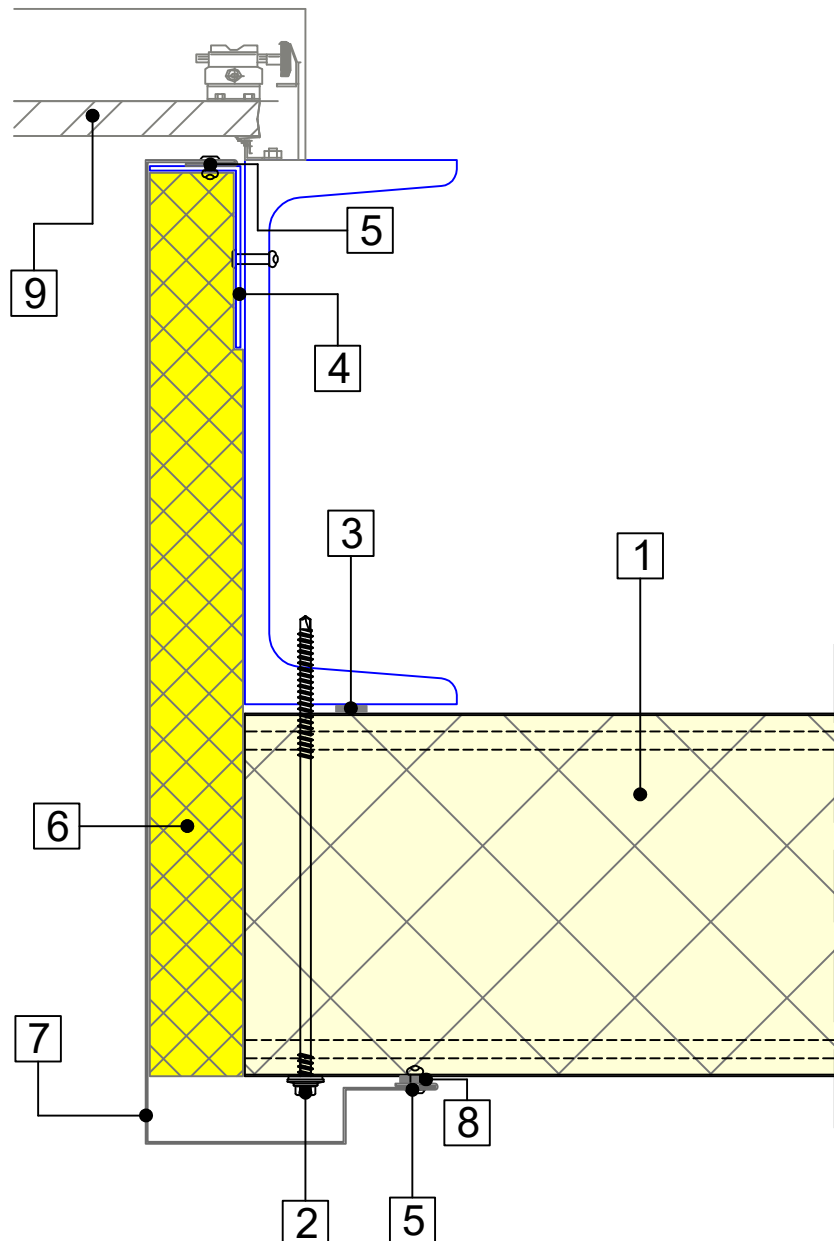

DAGKANT PROFIEL

$d \geq 0.60 \text{ mm}$



Nr.	Omschrijving	Schaal: 1:2.5
1	Sandwichpaneel	
2	Bevestigingsmiddel	
3	Zelfklevende afdichtingsband PE	
4	Stalen hoekje	
5	Popnagel	
6	Thermische isolatie	
7	Dagkant profiel	
8	Afdichtingsband PU	
9	Industriedeur; inbouw conform opgave leverancier	

GEVELS - HORIZONTALE MONTAGE
BUSINESS LINE BETA KV

G.CP.BL-H.08b
BOVENDETAIL INDUSTRIEDEUR
Verticale doorsnede

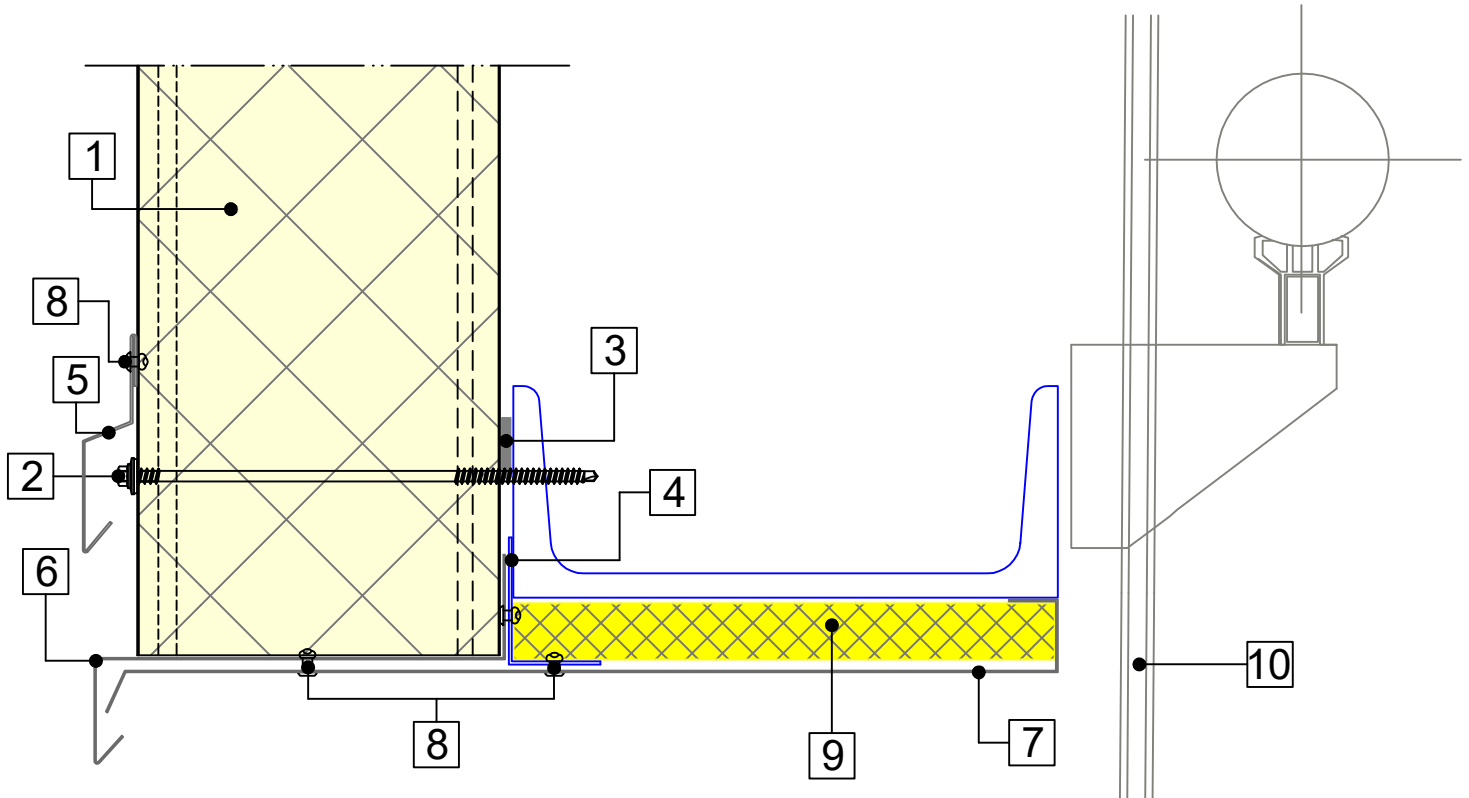

DEUR PROFIEL

$d \geq 0.60 \text{ mm}$



DAGKANT PROFIEL

$d \geq 0.60 \text{ mm}$



DRUP PROFIEL

$d \geq 0.60 \text{ mm}$



Nr.	Omschrijving	Schaal: 1:2.5
1	Sandwichpaneel	
2	Bevestigingsmiddel	
3	Zelfklevende afdichtingsband PE	
4	Stalen hoekje	
5	Drup profiel	
6	Deurprofiel	
7	Dagkant profiel	
8	Popnagel	
9	Thermische isolatie	
10	Industriedeur; inbouw conform opgave leverancier	