

TOEPASSING HELLEND DAK  
**BUSINESS LINE DELTA**

**CP.BL-HD.01a**  
 BEVESTIGING  
 Verticale doorsnede

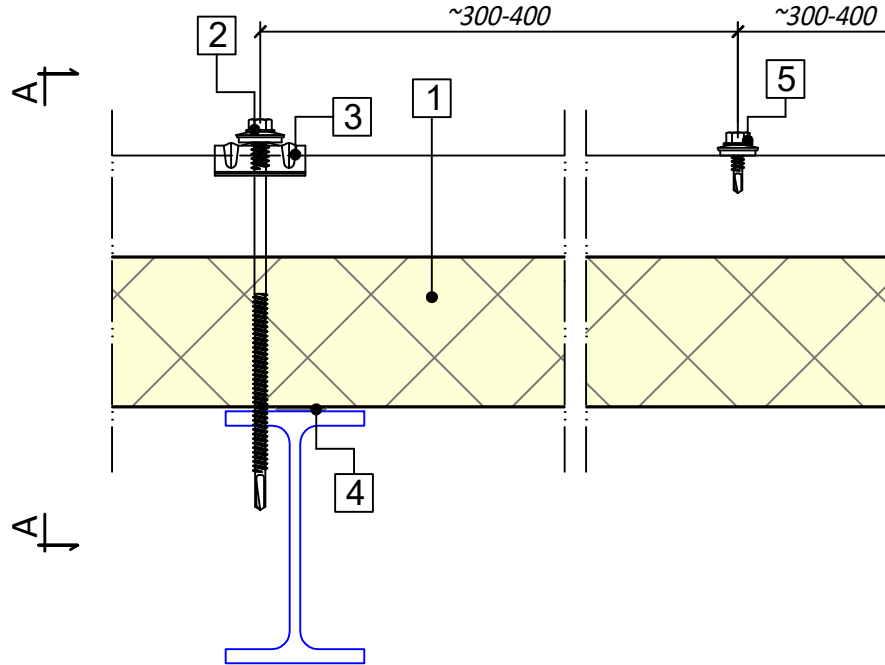

DOORSNEDE A-A

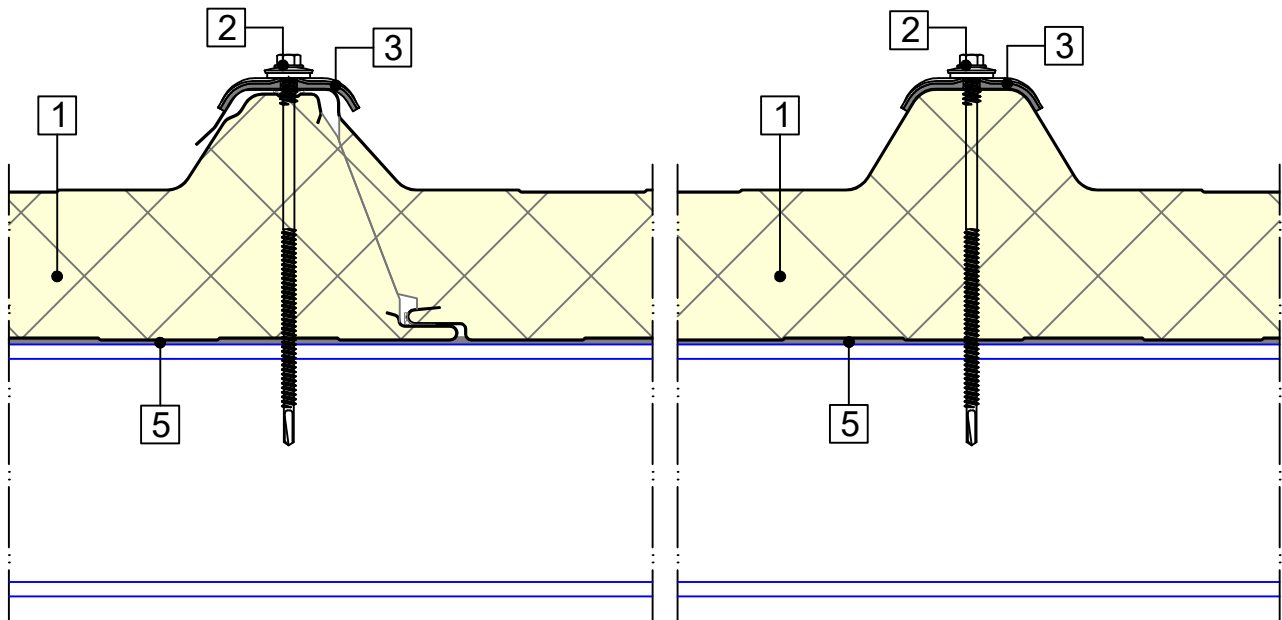

Nr.	Omschrijving	Schaal: 1:3
1	Sandwichpaneel	
2	Bevestigingsmiddel	
3	Kalot	
4	Zelfklevende afdichtingsband PE	
5	Zelfborende schroef - Ø4,8x19-25 mm	

TOEPASSING HELLEND DAK  
**BUSINESS LINE DELTA**

**CP.BL-HD.01b**  
 OVERLAP & CUTBACK  
 Verticale doorsnede

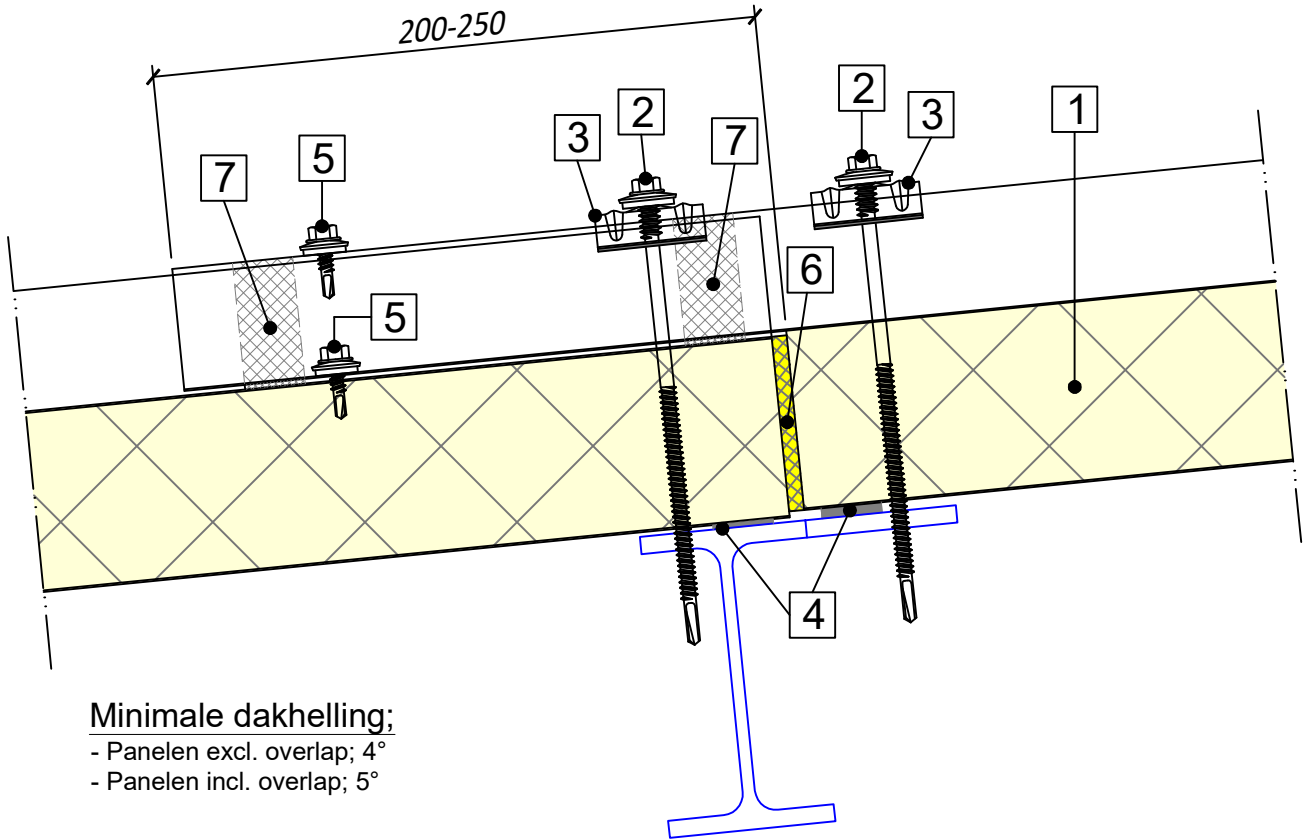

**Minimale dakhelling;**  
 - Panelen excl. overlap; 4°  
 - Panelen incl. overlap; 5°

**Cutback mogelijkheden**  
 (60-100-150-200-250-300)

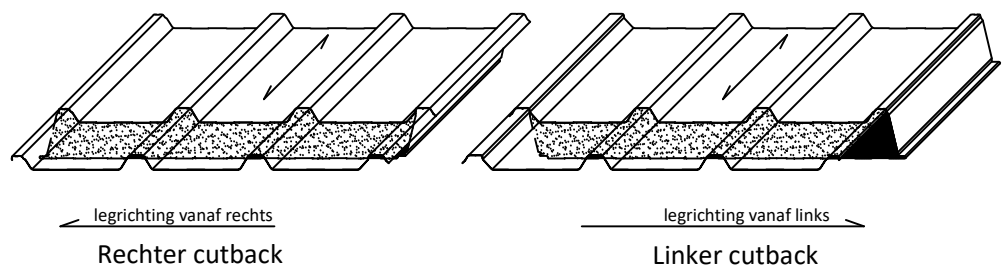

Nr.	Omschrijving	Schaal: 1:2.5
1	Sandwichpaneel	
2	Bevestigingsmiddel	
3	Kalot	
4	Zelfklevende afdichtingsband PE	
5	Zelfborende schroef - Ø4,8x19-25 mm	
6	Thermische isolatie	
7	Profielvuller	

TOEPASSING HELLEND DAK  
**BUSINESS LINE DELTA**

**CP.BL-HD.02a**  
 NOKAFWERKING  
 Verticale doorsnede

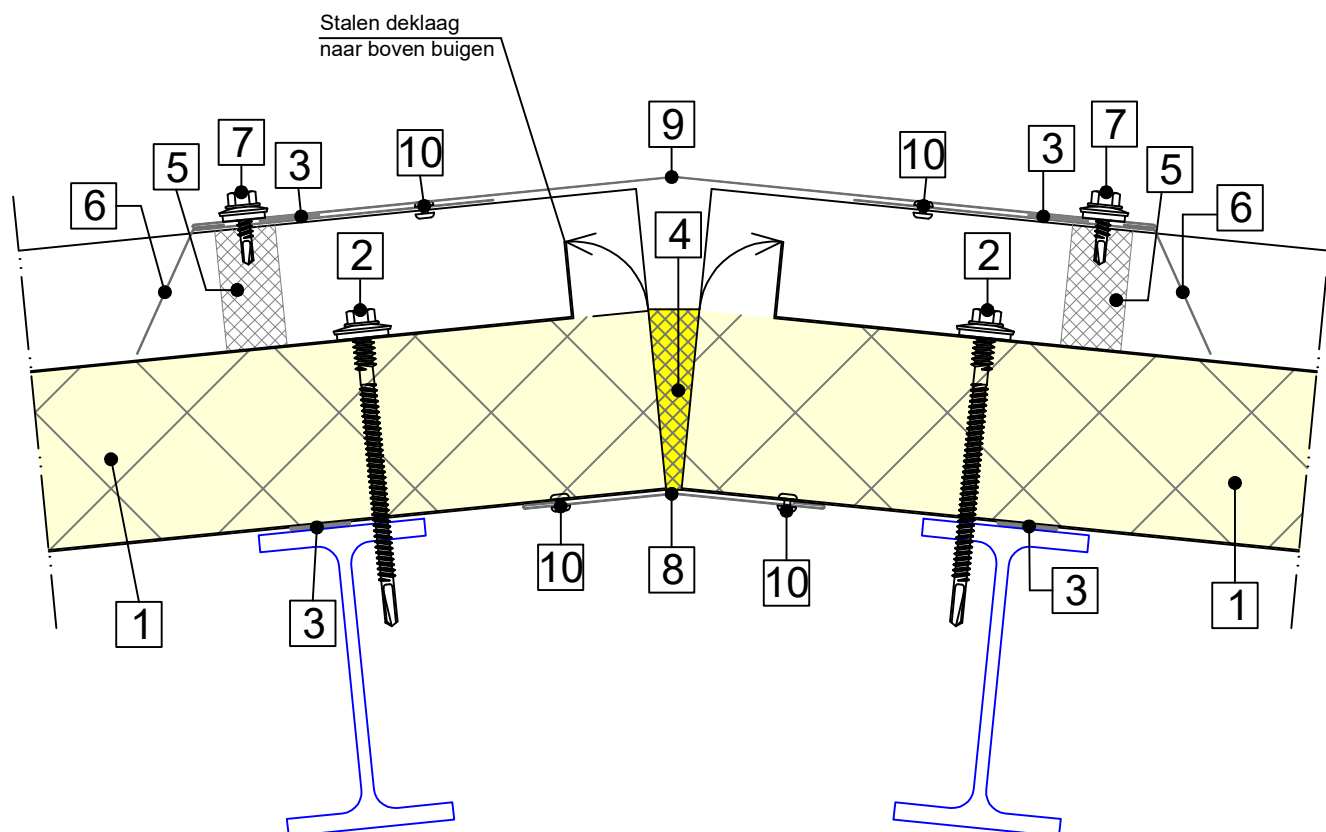

Nr.	Omschrijving	Schaal: 1:2.5
1	Sandwichpaneel	
2	Bevestigingsmiddel	
3	Zelfklevende afdichtingsband PE	
4	Thermische isolatie	
5	Profielvuller	
6	Afdekprofiel - vertand	
7	Zelfborende schroef - Ø4,8x19-25 mm	
8	Nokprofiel - intern	
9	Nokprofiel - extern	
10	Popnagel	

TOEPASSING HELLEND DAK  
**BUSINESS LINE DELTA**

**CP.BL-HD.02b**  
 AANSLUITING WAND  
 Verticale doorsnede

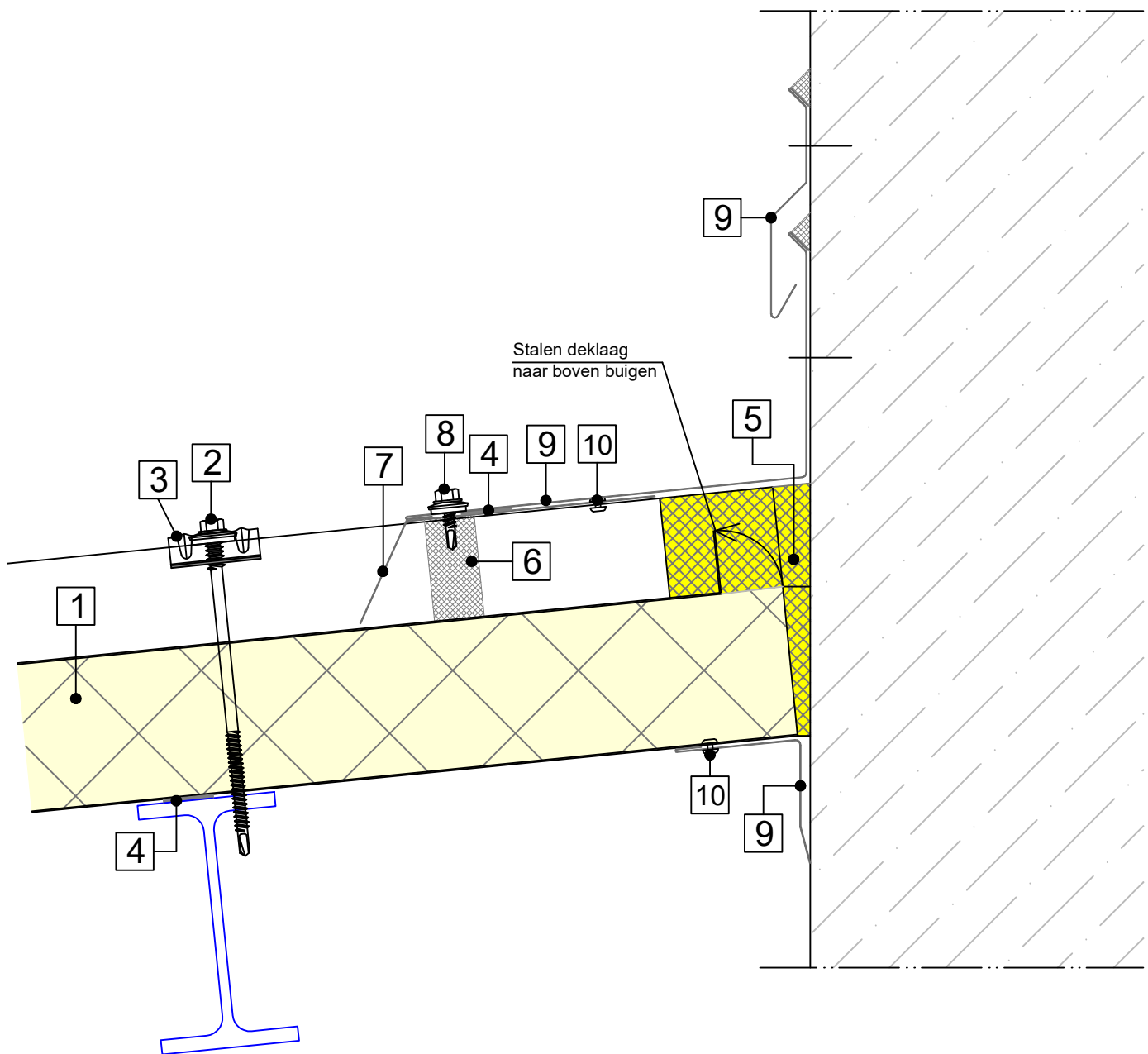

Nr.	Omschrijving	Schaal: 1:2.5
1	Sandwichpaneel	
2	Bevestigingsmiddel	
3	Kalot	
4	Zelfklevende afdichtingsband PE	
5	Thermische isolatie	
6	Profielvuller	
7	Afdekprofiel - vertand	
8	Zelfborende schroef - Ø4,8x19-25 mm	
9	Zetwerk	
10	Popnagel	

TOEPASSING HELLEND DAK  
**BUSINESS LINE DELTA**

**CP.BL-HD.03a**  
 BAKGOOT  
 Verticale doorsnede

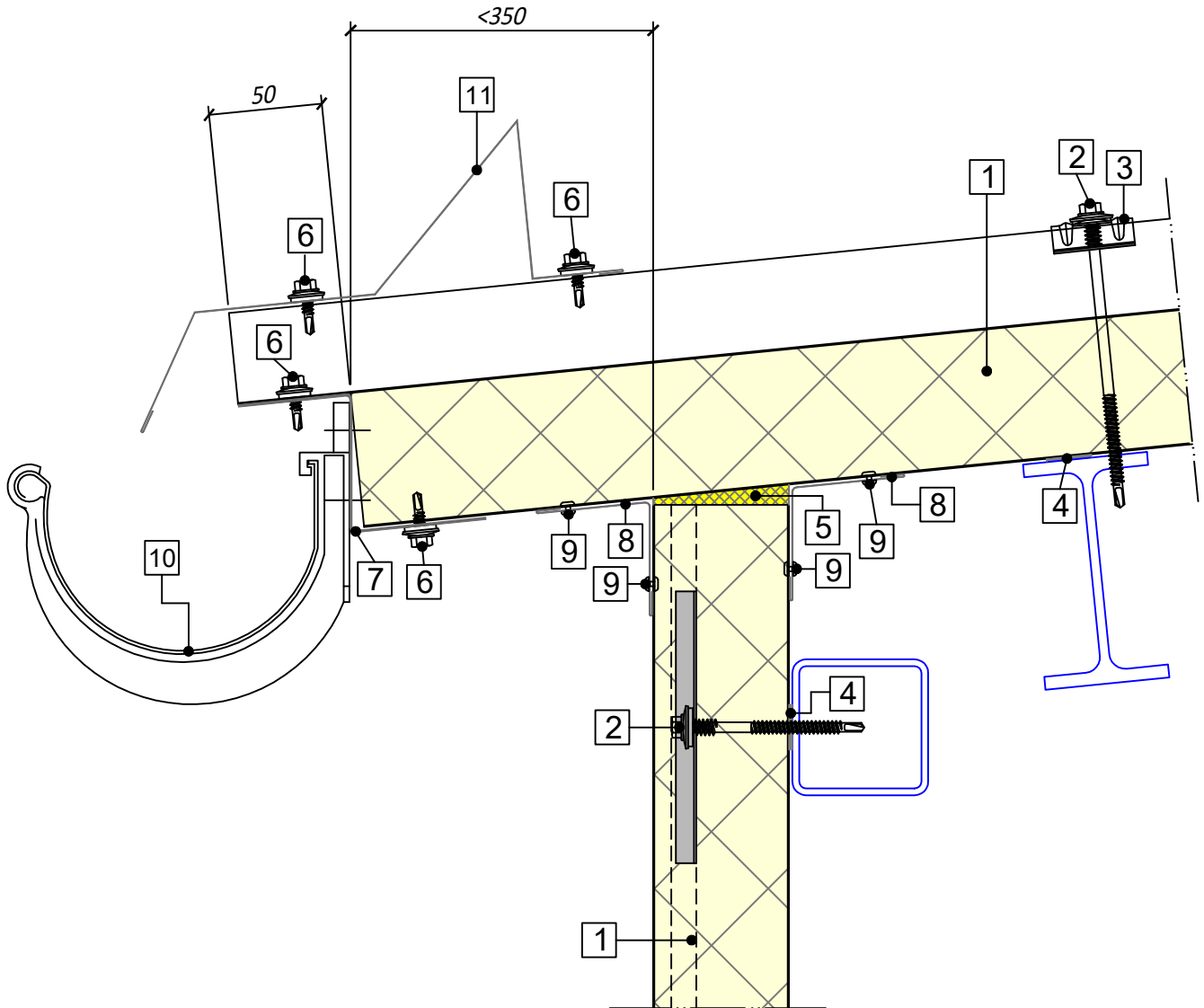

Nr.	Omschrijving	Schaal: 1:3
1	Sandwichpaneel	
2	Bevestigingsmiddel	
3	Kalot	
4	Zelfklevende afdichtingsband PE	
5	Thermische isolatie	
6	Zelfborende schroef - Ø4,8x19-25 mm	
7	Z-profiel t.b.v. goot	
8	Stalen hoek	
9	Popnagel	
10	Bakgoot	
11	Sneeuwvanger*	

\* Optioneel

TOEPASSING HELLEND DAK  
**BUSINESS LINE DELTA**

**CP.BL-HD.03b**  
 ZAKGROOT  
 Verticale doorsnede

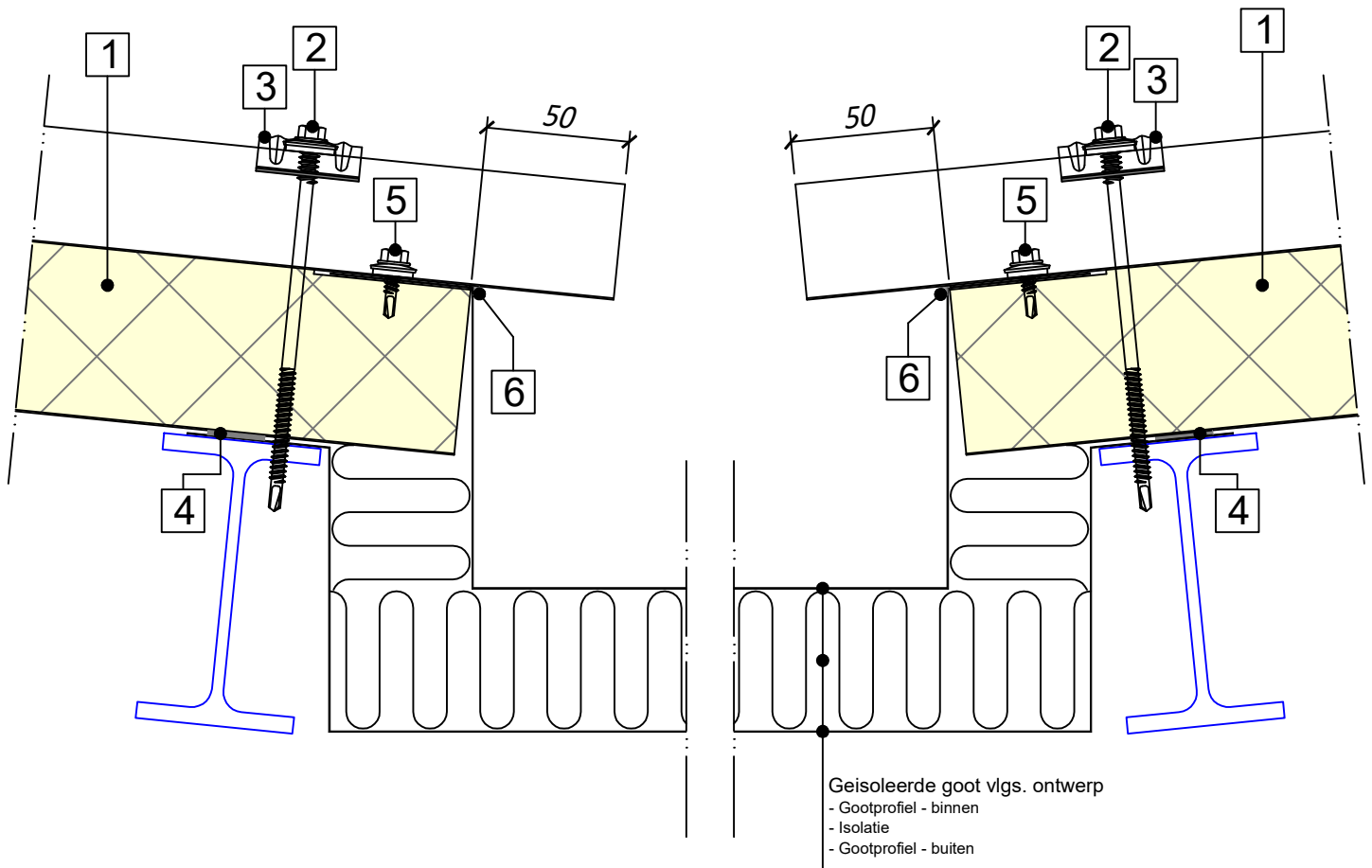

Nr.	Omschrijving	Schaal: 1:2.5
1	Sandwichpaneel	
2	Bevestigingsmiddel	
3	Kalot	
4	Zelfklevende afdichtingsband PE	
5	Zelfborende schroef - Ø4,8x19-25 mm	
6	Butyl afdichting	

TOEPASSING HELLEND DAK  
**BUSINESS LINE DELTA**

**CP-BL-HD.03C**  
INWENDIGE GOOT  
Verticale doorsnede

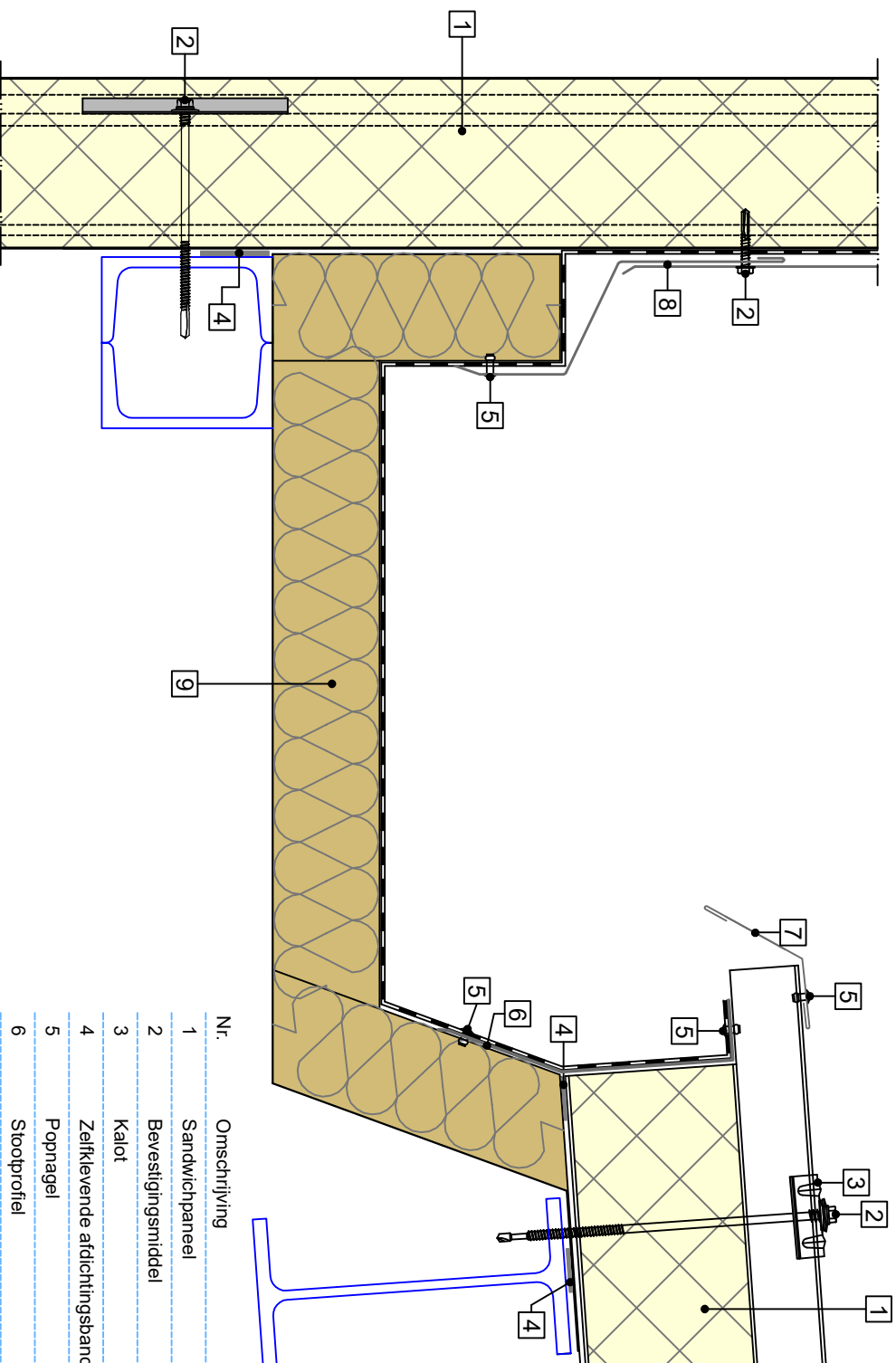

Schaal: 1:4

Nr.	Omschrijving
1	Sandwichpaneel
2	Bevestigingsmiddel
3	Kalot
4	Zelfklevende afdichtingsband PE
5	Popnagel
6	Stootprofiel
7	Goot Inloopprofiel
8	Zetwerk
9	Inwendige goot vlg. ontwerp

TOEPASSING HELLEND DAK  
**BUSINESS LINE DELTA**

**CP.BL-HD.04a**  
DAKRAND - OVERSTEEK WAND  
Verticale doorsnede

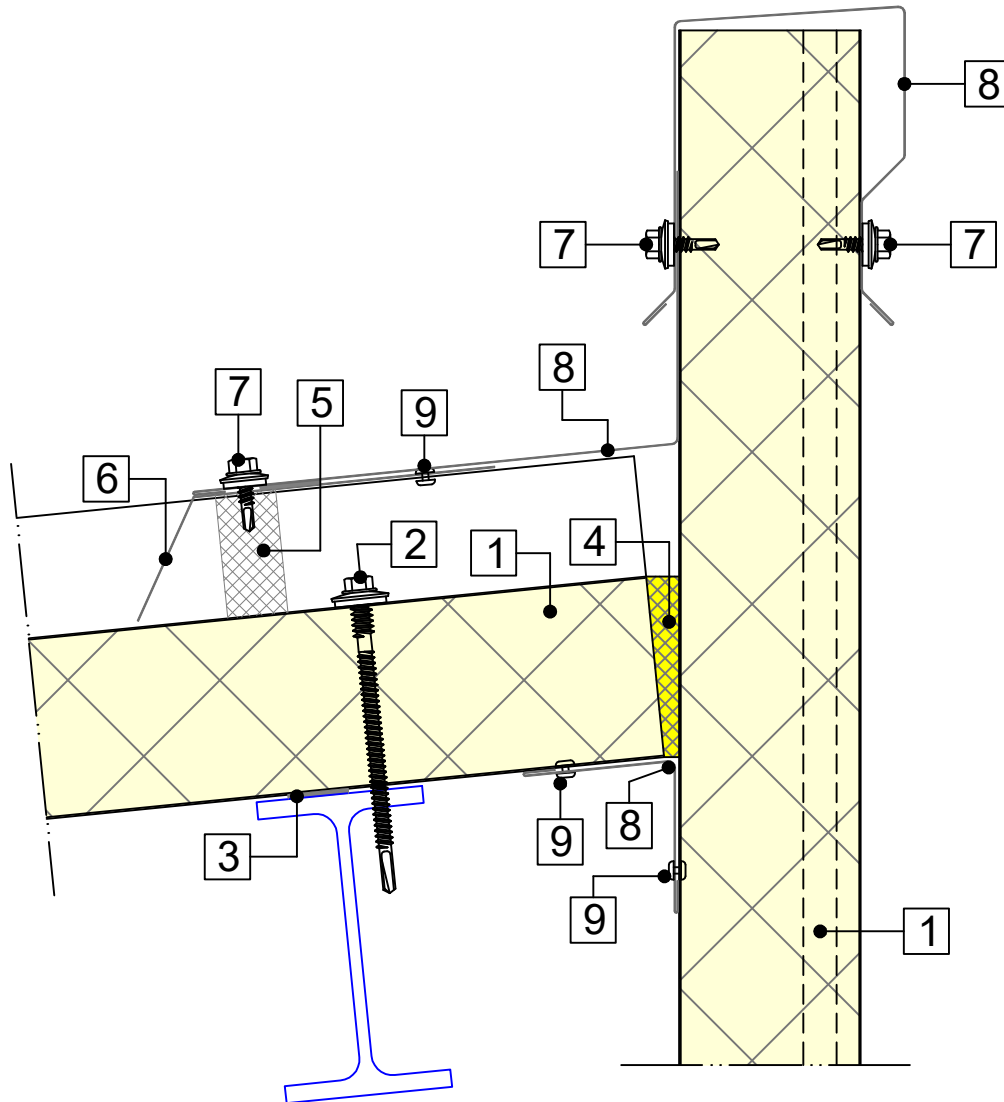

Nr.	Omschrijving	Schaal: 1:2.5
1	Sandwichpaneel	
2	Bevestigingsmiddel	
3	Zelfklevende afdichtingsband PE	
4	Thermische isolatie	
5	Profielvuller	
6	Afdekprofiel - vertand	
7	Zelfborende schroef - Ø4,8x19-25 mm	
8	Zetwerk	
9	Popnagel	



TOEPASSING HELLEND DAK  
**BUSINESS LINE DELTA**

**CP.BL-HD.04b**  
 DAKRAND - OVERSTEEK WAND  
 Verticale doorsnede

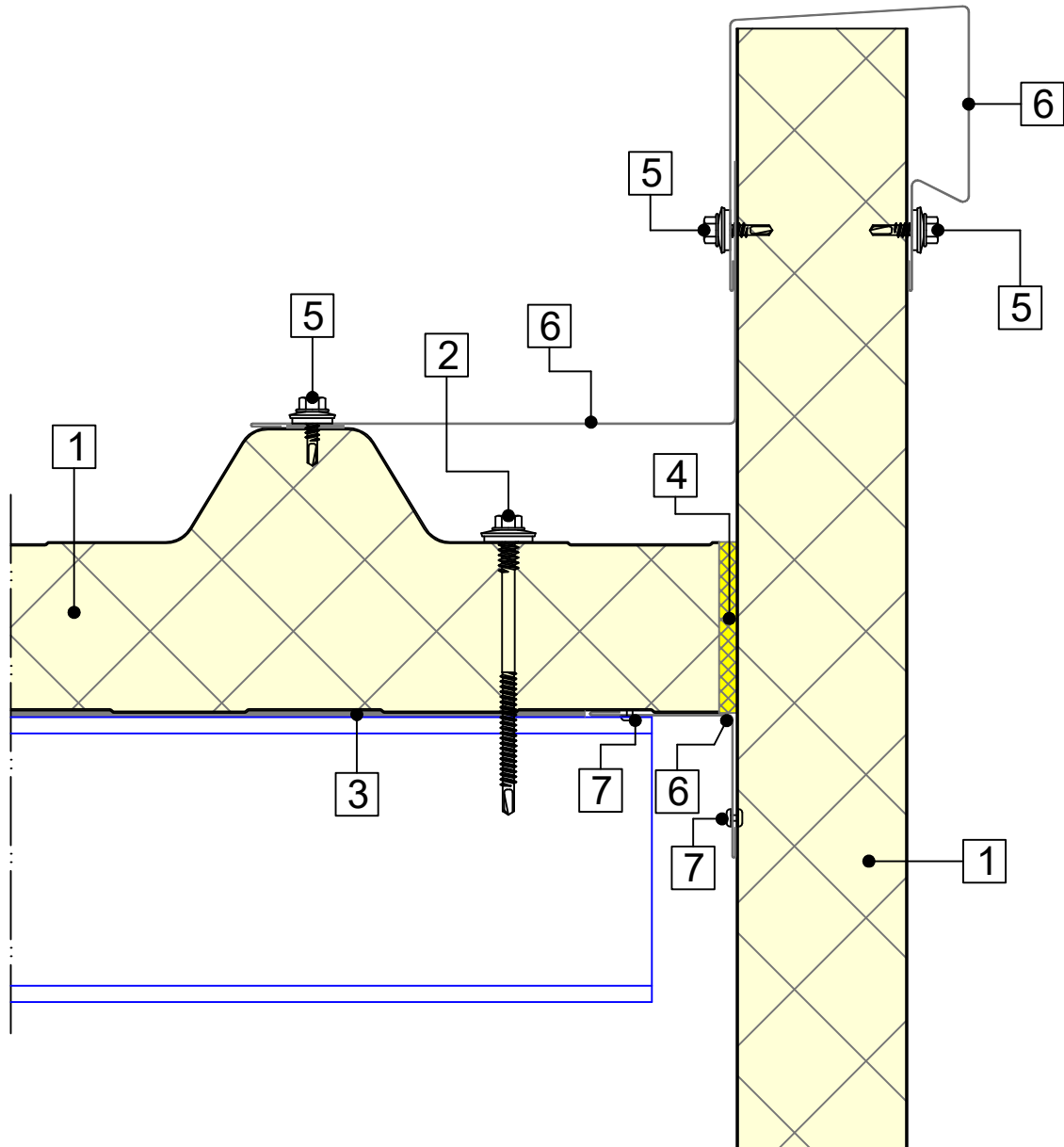

Nr.	Omschrijving	Schaal: 1:2.5
1	Sandwichpaneel	
2	Bevestigingsmiddel	
3	Zelfklevende afdichtingsband PE	
4	Thermische isolatie	
5	Zelfborende schroef - Ø4,8x19-25 mm	
6	Zetwerk	
7	Popnagel	

TOEPASSING HELLEND DAK  
**BUSINESS LINE DELTA**

**CP.BL-HD.04c**  
 DAKRAND - OVERSTEK DAK  
 Verticale doorsnede

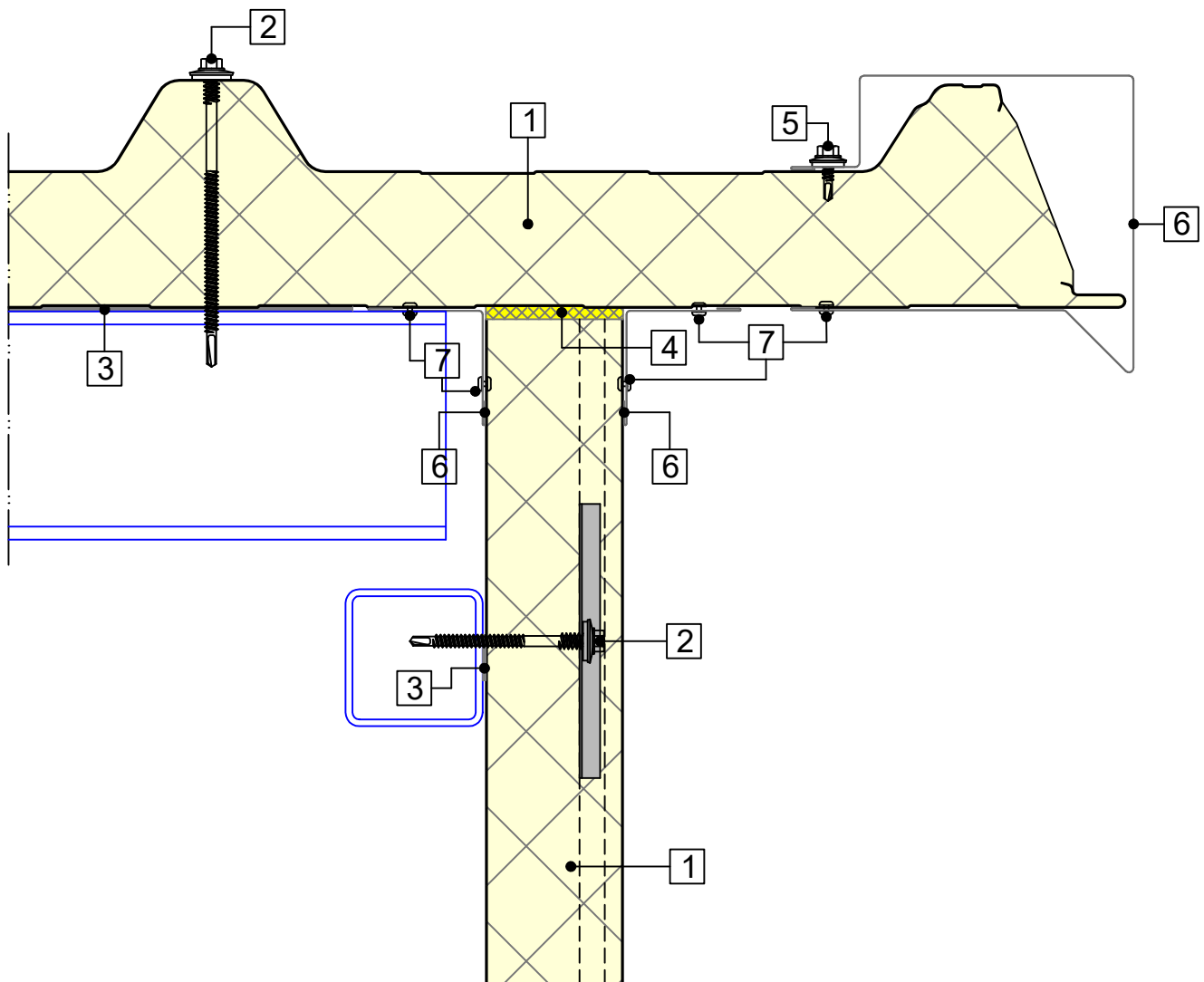

Nr.	Omschrijving	Schaal: 1:3
1	Sandwichpaneel	
2	Bevestigingsmiddel	
3	Zelfklevende afdichtingsband PE	
4	Thermische isolatie	
5	Zelfborende schroef - Ø4,8x19-25 mm	
6	Zetwerk	
7	Popnagel	

TOEPASSING HELLEND DAK  
**BUSINESS LINE DELTA**

**CP.BL-HD.04d**  
 DAKRAND - ZONDER OVERSTEK  
 Verticale doorsnede

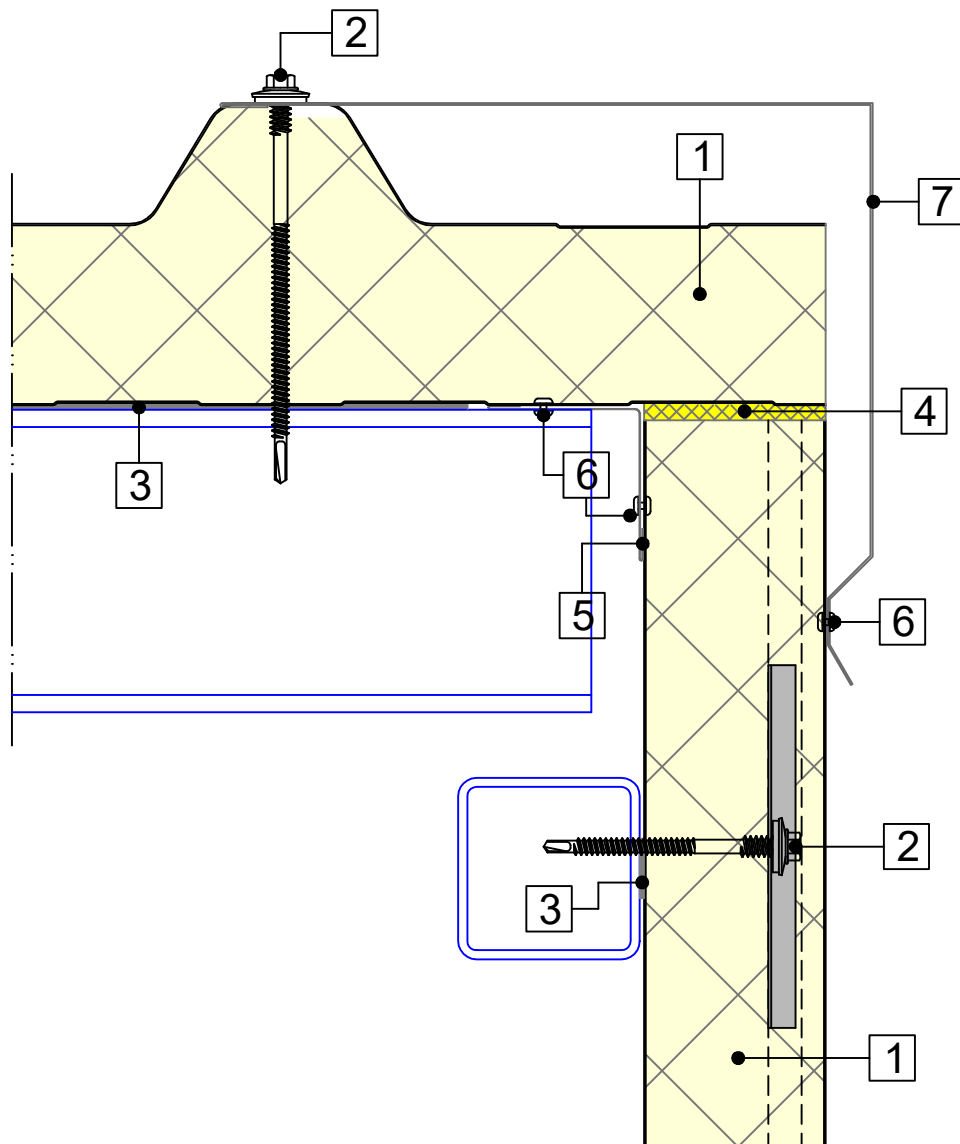

Nr.	Omschrijving	Schaal: 1:2.5
1	Sandwichpaneel	
2	Bevestigingsmiddel	
3	Zelfklevende afdichtingsband PE	
4	Thermische isolatie	
5	Inwendige hoekprofiel	
6	Popnagel	
7	Zetwerk	

TOEPASSING HELLEND DAK  
**BUSINESS LINE DELTA**

**CP.BL-HD.04e**  
 LESSENAARSDAK - OVERSTEK DAK  
 Verticale doorsnede

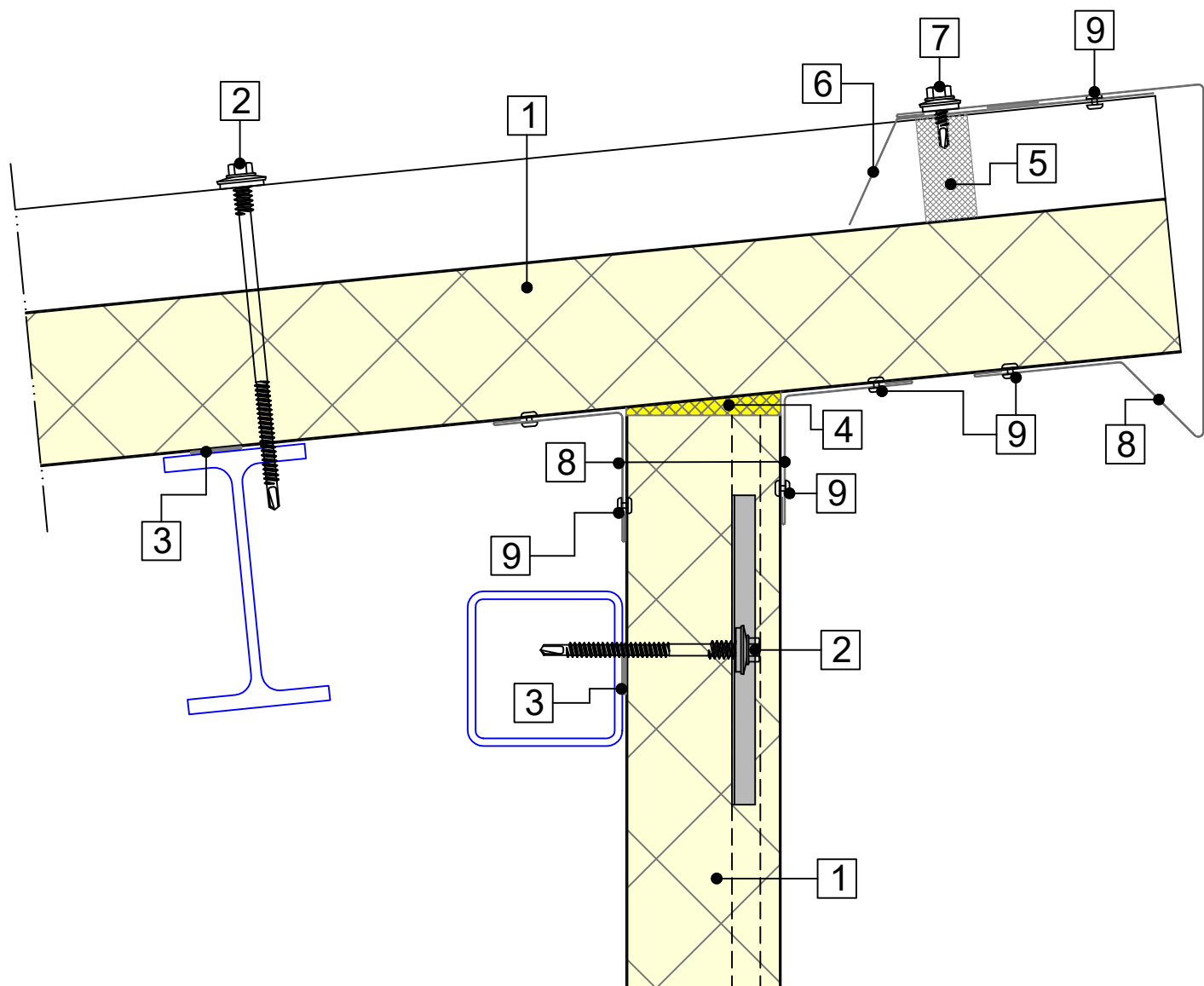

Nr.	Omschrijving	Schaal: 1:2.5
1	Sandwichpaneel	
2	Bevestigingsmiddel	
3	Zelfklevende afdichtingsband PE	
4	Thermische isolatie	
5	Profielvuller	
6	Afdekprofiel - vertand	
7	Zelfborende schroef - Ø4,8x19-25 mm	
8	Zetwerk	
9	Popnagel	

TOEPASSING HELLEND DAK  
**BUSINESS LINE DELTA**

**CP.BL-HD.04f**  
 LESSENAARS DAK - ZONDER OVERSTEK  
 Verticale doorsnede

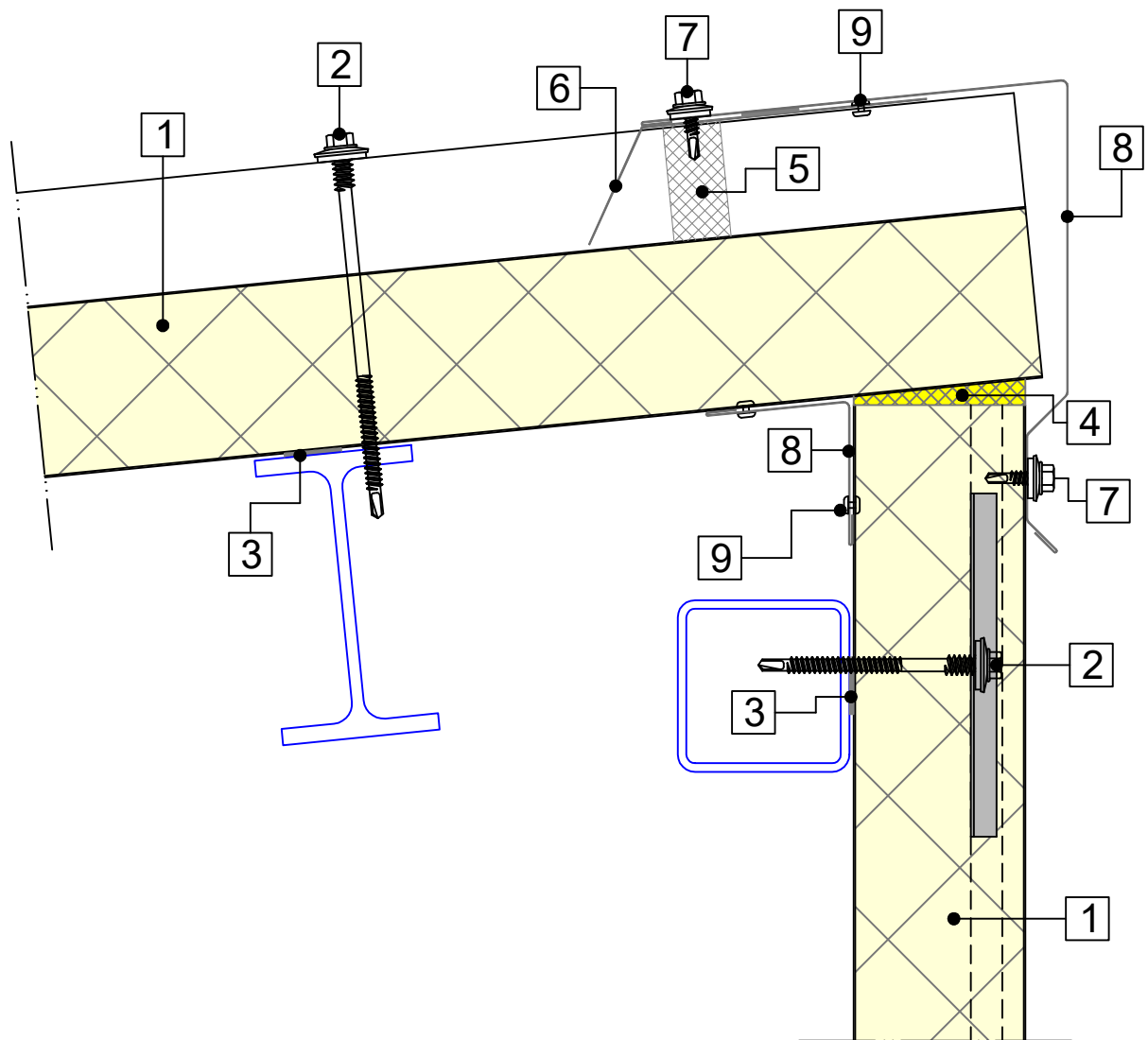

Nr.	Omschrijving	Schaal: 1:2.5
1	Sandwichpaneel	
2	Bevestigingsmiddel	
3	Zelfklevende afdichtingsband PE	
4	Thermische isolatie	
5	Profielvuller	
6	Afdekprofiel - vertand	
7	Zelfborende schroef - Ø4,8x19-25 mm	
8	Zetwerk	
9	Popnagel	

TOEPASSING HELLEND DAK  
**BUSINESS LINE DELTA**

**CP.BL-HD.05a**  
 DETAIL - LICHTKOEPEL  
 Verticale doorsnede

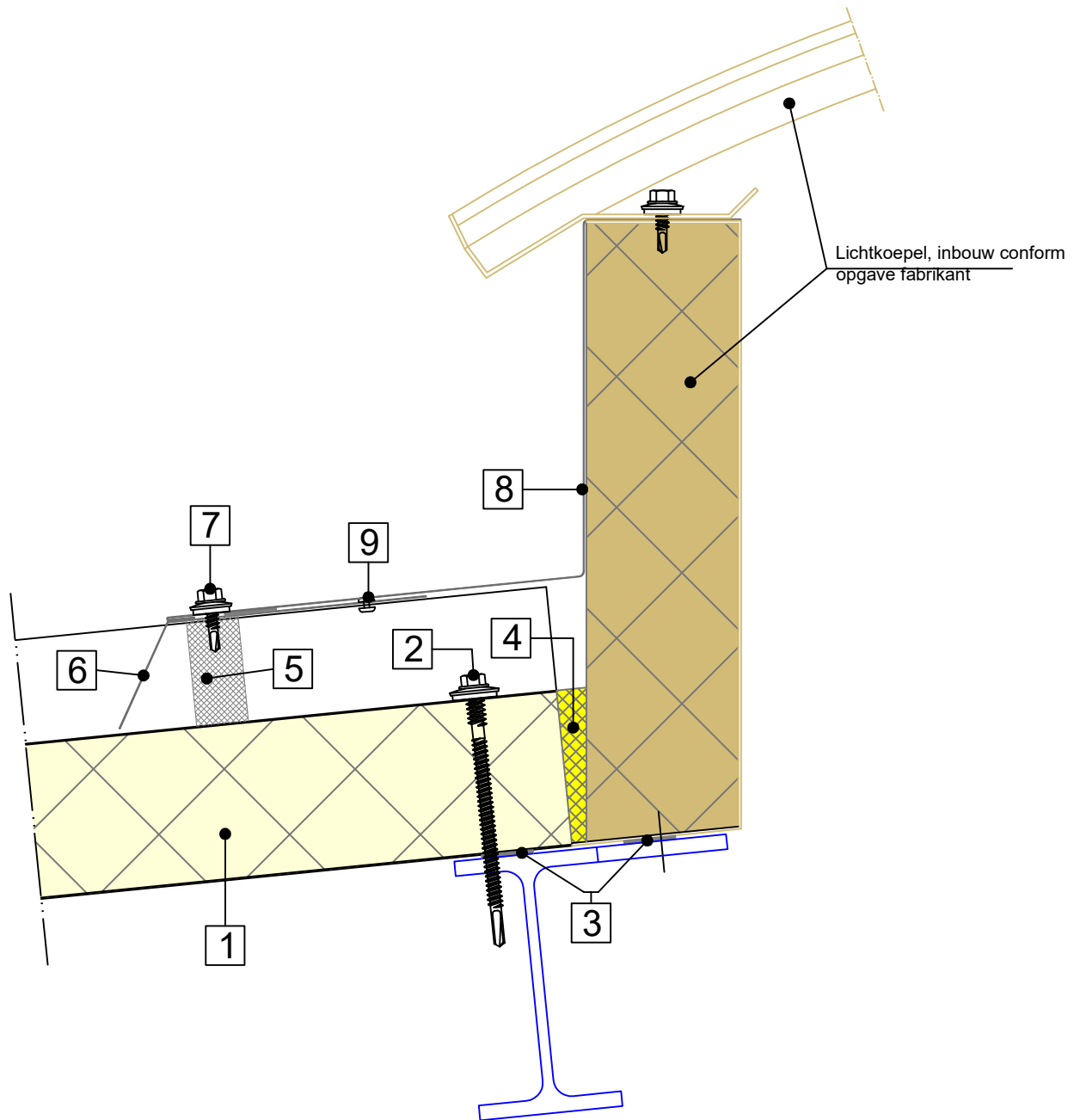

Nr.	Omschrijving	Schaal: 1:2.5
1	Sandwichpaneel	
2	Bevestigingsmiddel	
3	Zelfklevende afdichtingsband PE	
4	Thermische isolatie	
5	Profielvuller	
6	Afdekprofiel - vertand	
7	Zelfborende schroef - Ø4,8x19-25 mm	
8	Zetwerk	
9	Popnagel	

TOEPASSING HELLEND DAK  
**BUSINESS LINE DELTA**

**CP.BL-HD.05b**  
DETAIL - DAKDOORVOER  
Verticale doorsnede

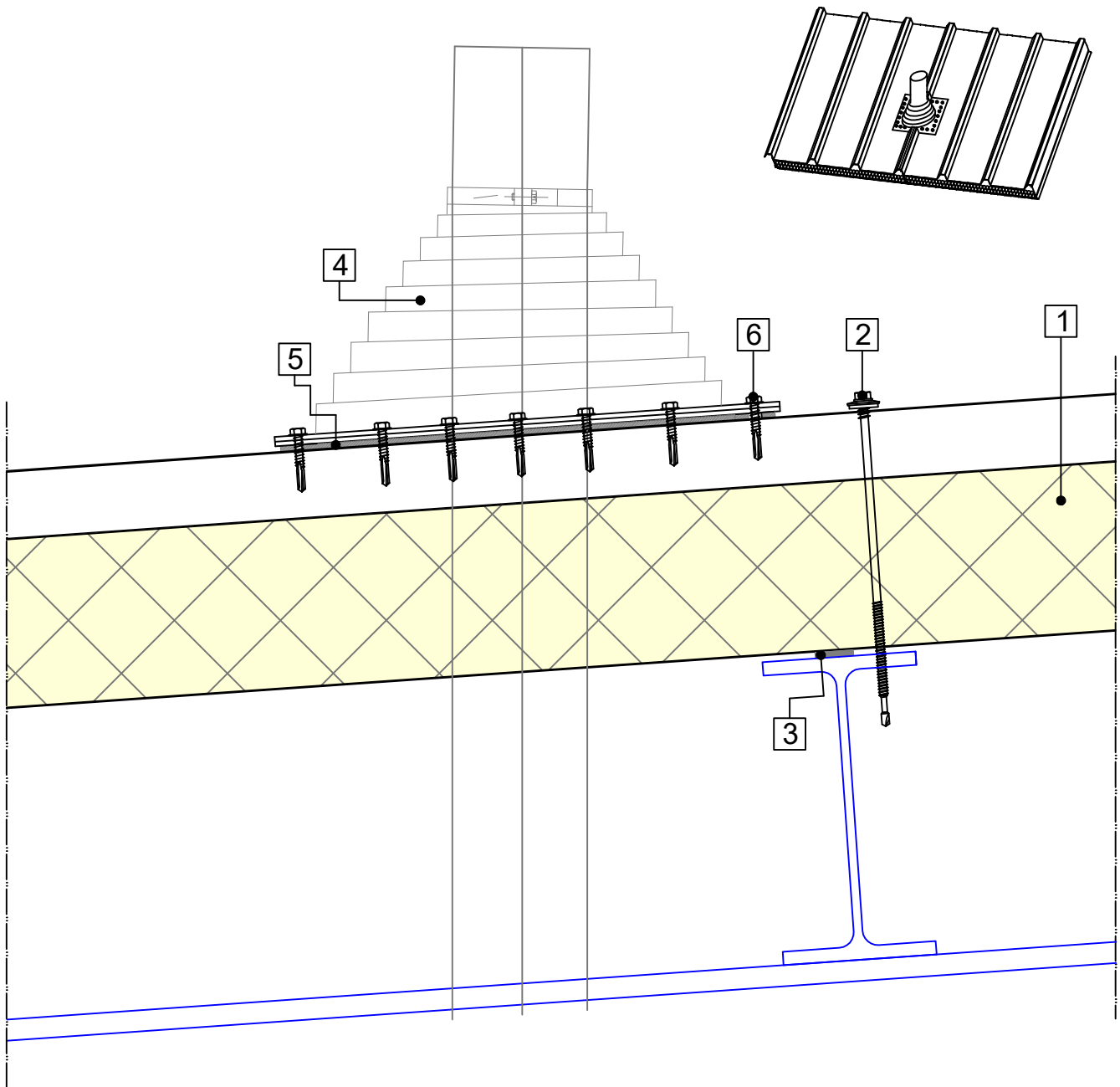

Nr.	Omschrijving	Schaal: 1:3
1	Sandwichpaneel	
2	Bevestigingsmiddel	
3	Zelfklevende afdichtingsband PE	
4	Afdichtingsflens voor dakdoorvoeren	
5	Afdichtingskit	
6	Zelfborende schroef - Ø4,8x19-25 mm	